

SHARP

Projector

X171Q-B/X171Q-W
X141Q-B/X141Q-W

Installation Manual

HDMITM

UHDTM
BT_{ASE}TM

DTM

Model No.
XP-X171Q-B/XP-X171Q-W/XP-X141Q-B/XP-X141Q-W

Table of Contents

Introduction	iii
Important Information	iv
1. Check the product overview, supplied items and part names	1
1-1. Introduction to the Projector	1
1-2. What's in the Box?	3
1-3. Part Names of the Projector	4
1-4. Part Names of the Remote Control	11
2. Projecting an Image (Basic Operation)	17
2-1. Flow of Projecting an Image	17
2-2. Connecting Your Computer/Connecting the Power Cord	18
2-3. Turning on the Projector	20
2-4. Selecting a Source	23
2-5. Adjusting the Picture Size and Position	24
2-6. Turning off the Projector	31
2-7. After Use	32
3. Convenient Features	33
3-1. Turn off the light of the projector (SHUTTER)	33
3-2. Turning Off the On-Screen Menu (On-Screen Mute)	33
3-3. Enlarging a Picture	34
3-4. Adjustment of luminance (brightness)	35
3-5. Correcting Horizontal and Vertical Keystone Distortion [KEYSTONE]	36
3-6. Controlling the Projector by Using an HTTP Browser	37
3-7. Storing Changes for Lens Shift [LENS MEMORY]	39
3-8. Adjust boundaries of a projected image [EDGE BLENDING]	41

4. Using On-Screen Menu	45
4-1. Basic operations of the on-screen menu	45
4-2. List of Menu Items	48
4-3. INPUT	52
4-4. ADJUST	54
4-5. DISPLAY	58
4-6 SETUP(1)	67
4-7. SETUP(2)	72
4-8. INFO.	74
5. Attachment/detachment of lens unit	75
6. Connecting to Other Equipment	79
6-1. Connecting to a computer or video device	80
6-2. Connecting to a HDBaseT transmission device (sold commercially)	81
6-3. Connecting to a Wired LAN	82
7. Maintenance	83
7-1. Cleaning the Lens	83
7-2. Cleaning the Cabinet	84
8. Appendix	85
8-1. Throw distance and screen size	85
8-2. Compatible Input Signal List	91
8-3. Specifications	94
8-4. Cabinet Dimensions	97
8-5. Pin assignments and signal names of main connectors	98
8-6. Portrait projection (vertical orientation)	101
8-7. Stacking projectors	103
8-8. Troubleshooting	105
8-9. PC Control Codes and Cable Connection	111
8-10. Troubleshooting Check List	113
8-11. Setting the login password for the HTTP server screen	115
8-12. Registering a background logo	117

Introduction

Thank you for purchasing the projector.

This projector can be connected to computers, video devices, etc. to project images sharply onto a screen.

Please read this manual carefully before using your projector.

Read this manual if you have any doubts about operation or if you believe the projector may be faulty.

NOTES

- (1) The contents of this manual may not be reprinted in part or whole without permission.
- (2) The contents of this manual are subject to change without notice.
- (3) Great care has been taken in the preparation of this manual; however, should you notice any questionable points, errors or omissions, please contact us.
- (4) The image shown in this manual is indicative only. If there is inconsistency between the image and the actual product, the actual product shall govern.
- (5) Notwithstanding article (3) and (4), we will not be responsible for any claims on loss of profit or other matters deemed to result from using this device.
- (6) This manual is commonly provided to all regions so they may contain descriptions that are pertinent for other countries.

Important Information

Supplier's Declaration of Conformity

SHARP PROJECTOR, XP-X171Q-B/XP-X171Q-W/XP-X141Q-B/XP-X141Q-W

This device complies with Part 15 of the FCC Rules. Operation is subject to the following two conditions: (1) This device may not cause harmful interference, and (2) this device must accept any interference received, including interference that may cause undesired operation.

Responsible Party: SHARP ELECTRONICS CORPORATION
100 Paragon Drive, Montvale, NJ 07645
TEL: (630) 467-3000 www.sharppusa.com

WARNING:

FCC Regulations state that any unauthorized changes or modifications to this equipment not expressly approved by the manufacturer could void the user's authority to operate this equipment.

NOTE:

This equipment has been tested and found to comply with the limits for a Class A digital device, pursuant to Part 15 of the FCC Rules. These limits are designed to provide reasonable protection against harmful interference when the equipment is operated in a commercial environment. This equipment generates, uses, and can radiate radio frequency energy and, if not installed and used in accordance with the instruction manual, may cause harmful interference to radio communications.

Operation of this equipment in a residential area is likely to cause harmful interference in which case the user will be required to correct the interference at his own expense.

U.S.A. ONLY

Cable information

Use shielded cables to prevent interference with radio or television reception.

Notice Concerning Electromagnetic Interference (EMI) (For other regions)

WARNING:

Operation of this equipment in a residential environment could cause radio interference.

(For Customers in U.K.)

IMPORTANT

- The wires in this mains lead are coloured in accordance with the following code:

GREEN-AND-YELLOW:	“Earth”
BLUE:	“Neutral”
BROWN:	“Live”

- As the colours of the wires in the mains lead of this apparatus may not correspond with the coloured markings identifying the terminals in your plug proceed as follows:
- The wire which is coloured GREEN-AND-YELLOW must be connected to the terminal in the plug which is marked by the letter **E** or by the safety earth symbol \perp or coloured green or green-and-yellow.
- The wire which is coloured BLUE must be connected to the terminal which is marked with the letter **N** or coloured black.
- The wire which is coloured BROWN must be connected to the terminal which is marked with the letter **L** or coloured red.
- Ensure that your equipment is connected correctly. If you are in any doubt consult a qualified electrician.

“WARNING: THIS APPARATUS MUST BE EARTHED.”



Information on the Disposal of this Equipment and its Batteries

IF YOU WISH TO DISPOSE OF THIS EQUIPMENT OR ITS BATTERIES, DO NOT USE THE ORDINARY WASTE BIN, AND DO NOT PUT THEM INTO A FIREPLACE!

Used electrical and electronic equipment and batteries should always be collected and treated SEPARATELY in accordance with local law.

Separate collection promotes an environment-friendly treatment, recycling of materials, and minimizing final disposal of waste. IMPROPER DISPOSAL can be harmful to human health and the environment due to certain substances! Take USED EQUIPMENT to a local, usually municipal, collection facility, where available.

Remove USED BATTERIES from equipment, and take them to a battery collection facility; usually a place where new batteries are sold.

If in doubt about disposal, contact your local authorities or dealer and ask for the correct method of disposal.

ONLY FOR USERS IN THE EUROPEAN UNION, AND SOME OTHER COUNTRIES; FOR INSTANCE NORWAY AND SWITZERLAND: Your participation in separate collection is requested by law.

The symbol shown above appears on electrical and electronic equipment and batteries (or the packaging) to remind users of this. If 'Hg' or 'Pb' appears below the symbol, this means that the battery contains traces of mercury (Hg) or lead (Pb), respectively.

Users from PRIVATE HOUSEHOLDS are requested to use existing return facilities for used equipment and batteries.

Batteries are collected at points of sale. Return is free of charge.

If the equipment has been used for BUSINESS PURPOSES, please contact your SHARP dealer who will inform you about take-back. You might be charged for the costs arising from take-back. Small equipment (and small quantities) might be taken back by your local collection facility.

For Spain: Please contact the established collection system or your local authority for take-back of your used products.

(for Germany only)



Machine Noise Information Regulation - 3. GPSGV,

The highest sound pressure level is less than 70 dB (A) in accordance with EN ISO 7779.









About the symbols

To ensure safe and proper use of the product, this manual uses a number of symbols to prevent injury to you and others as well as damage to property.

The symbols and their meanings are described below. Be sure to understand them thoroughly before reading this manual.

 WARNING	Failing to heed this symbol and handling the product erroneously could result in accidents leading to death or major injury.
 CAUTION	Failing to heed this symbol and handling the product erroneously could result in personal injury or damage to surrounding property.

Examples of symbols

	This symbol indicates you should be careful of electric shocks.
	This symbol indicates you should be careful of high temperatures.
	This symbol indicates something that must be prohibited.
	This symbol indicates something that must not be got wet.
	This symbol indicates you should not touch with wet hands.
	This symbol indicates something that must not be disassembled.
	This symbol indicates things you must do.
	This symbol indicates that the power cord should be unplugged from the power outlet.

Safety Cautions

WARNING

Projected light



PROHIBITED

Projected light and the pictogram/label indicated on the cabinet

- Do not look into the projector's lens.
Strong light that could damage your vision is projected when the projector is operating. Laser energy exposure near aperture may cause burns. Be especially careful when children are around.
- Do not look at the projected light using optical devices (magnifying glasses, reflectors, etc.). Doing so could result in vision impairment.
- Check that there is no one looking at the lens within the projection range before turning on the projector.
- Do not allow children to operate the projector alone. When a child is operating the projector an adult should always be present and watch the child carefully.
- The below pictogram, that is indicated near the lens on the cabinet, describes looking into the projector is prohibited.

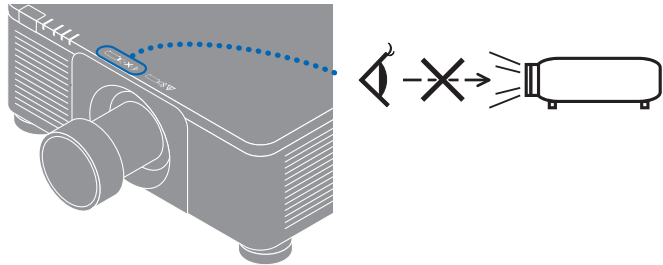

Continue to next page

WARNING

- The following labels are stuck on the projector.

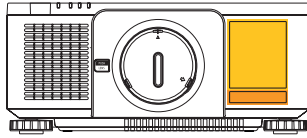

X171Q-B/X171Q-W

<p>This product is in conformity with performance standards for laser products under 21 CFR 1040, except with respect to those characteristics authorized by Variance Number FDA-2015-4413 effective on September 19, 2022.</p>	
<p>RISK GROUP 3 WARNING DO NOT LOOK INTO THE BEAM. NO DIRECT EYE EXPOSURE TO THE BEAM IS PERMITTED. HAZARD DISTANCE. REFER TO THE MANUAL.</p>	<p>高危険組 3 警告 直射レーザー光線を直接見たり、危険距離を越えて見たりしないでください。 危険距離: 取扱説明書参照。 IEC/EN 62471-5:2015</p>
<p>GROUPE DE RISQUE 3 MISE EN GARDE NE PAS REGARDER DIRECTEMENT DANS LE FAISCEAU. L'EXPOSITION DIRECTE DES YEUX AU FAISCEAU EST INTERDITE. DISTANCE À RISQUE: SE REPORTER AU MANUEL.</p>	<p>高危険組 3 警告 直射レーザー光線を直接見たり、危険距離を越えて見たりしないでください。 危険距離: 取扱説明書参照。 IEC/EN 62471-5:2015</p>
<p>RISIKOGRUPPE 3 WARNING SCHAUEN SIE NICHT IN DEN STRAHLEN. DIREKTES AUGENKONTAKT MIT DEM STRAHLEN IST NICHT ERLAUBT. SICHERHEITSSABSTAND: SIEHE HANDBUCH.</p>	<p>高危険組 3 警告 直射レーザー光線を直接見たり、危険距離を越えて見たりしないでください。 危険距離: 取扱説明書参照。 IEC/EN 62471-5:2015</p>
<p>ГРУППА РИСКА 3 ПРЕДУПРЕЖДЕНИЕ НЕ СМОТРИТЕ ПРЯМО В ЛАЗЕРНЫЙ ПУЧОК. ОПАСНОЕ РАСТояНИЕ: СМ. РУКОВОДСТВО ПО ЭКСПЛУАТАЦИИ.</p>	<p>高危険組 3 警告 直射レーザー光線を直接見たり、危険距離を越えて見たりしないでください。 危険距離: 取扱説明書参照。 IEC/EN 62471-5:2015</p>
<p>ラスグループ 3 警告 ビームを見ないこと。 目へのビームの直接曝露は禁止する。 危険距離: 取扱説明書参照。 위험 그룹 3 경고 빔을 보지 마십시오. 눈을 직접 레이저에 노출하는 것은 허용되지 않습니다. 위험 거리: 설명서를 참조하십시오.</p>	<p>高危険組 3 警告 直射レーザー光線を直接見たり、危険距離を越えて見たりしないでください。 危険距離: 取扱説明書参照。 IEC/EN 62471-5:2015</p>
<p>CLASS 1 LASER PRODUCT LASERPRODUKT DER KLASSE 1 APPAREIL À LASER DE CLASSE 1 ЛАЗЕРНОЕ ПРОДУКТ КЛАССА 1 第一級雷射產品 クラス1レーザー製品</p>	<p>IEC/EN 60825-1:2014 JIS C 6802:2018</p>

This projector is classified as risk group 3 of IEC/EN 62471-5:2015.

X141Q-B/X141Q-W

<p>This product is in conformity with performance standards for Laser products under 21 CFR 1040, except with respect to those characteristics authorized by Variance Number FDA-2015-4413 effective on September 19, 2022.</p>	
<p>CAUTION ! Do not stare into the beam RG2 This projector may become RG3 when an interchangeable lens with throw ratio greater than 2.1220:1 is installed. Refer to the manual for the lens list and hazard distance before operation. Such combinations of projector and lens are intended for professional use only, and are not intended for consumer use.</p>	<p>注意！請勿直視光束 RG2 當安裝投射比大於2.12:1的可替換鏡頭時，本投影機可能成為RG3產品。 請參閱說明書的鏡頭列表與危險距離，在操作前使用。 投影機和鏡頭的這種組合僅供專業人士使用，不適用於一般消費者，也不適用於一般家庭。</p>
<p>ATTENTION ! Ne pas regarder dans le faisceau RG2 Ce projecteur peut devenir RG3 lorsqu'un objectif interchangeable avec un rapport de projection supérieur à 2,12 est installé. Avant utilisation, reportez-vous au manuel pour trouver la liste des objectifs. Ces combinaisons de projecteur et d'objectif sont destinées à un usage professionnel uniquement et ne sont pas destinées à une utilisation grand public.</p>	<p>注意！請勿直視光束 RG2 當安裝投射比大於2.12:1的可替換鏡頭時，本投影機可能成為RG3產品。 鏡頭及危險距離的說明，請參閱使用手冊。 投影機和鏡頭的這種組合僅供專業人士使用，不適用於一般消費者，也不適用於一般家庭。</p>
<p>CLASS 1 LASER PRODUCT APPAREIL À LASER DE CLASSE 1 LASERPRODUKT DER KLASSE 1 ЛАЗЕРНОЕ КОМПОНЕНТ КЛАССА 1 第一級雷射產品 クラス1レーザー製品</p>	<p>COMSUMER LASER PRODUCT APPAREIL À LASER GRAND PUBLIC VERBODEN TOEGANG LASERPRODUCT EN 60825-1:2014+A11:2021 EN 60825:2012 IEC/EN 60825-1:2014 JIS C 6802:2018</p>

- This product complies with EN 50689:2021 except using the lens of XP-62ZL.
- This projector is classified as either IEC/EN 62471-5:2015 risk group 2 or risk group 3 depending on the lens unit.

- When classified as risk group 3, this projector is intended for professional use and must be installed by professional installer to ensure safety. See page xx for risk groups.
- See page xviii for Laser Safety Caution.

 **WARNING**

Power supply



REQUIRED

Use a suitable voltage power supply.

- This projector is designed to be used with a 100–240 VAC, 50/60 Hz power supply. Before using the projector, check that the power supply to which the projector is to be connected meets these requirements.
- Use a power outlet as the projector's power supply. Do not connect the projector directly to electrical light wiring. Doing so is dangerous.



**MUST BE
EARTHED**

Connecting the power cord to earth

- This equipment is designed to be used in the condition of the power cord connected to earth. If the power cord is not connected to the earth, it may cause electric shock. Please make sure the power cord is connected to the wall outlet directly and earthed properly.
Do not use a 2-pin plug converter adapter.
- Be sure to connect the projector and the computer (signal source) to the same earth point. If the projector and the computer (signal source) will be connected to different earth points, fluctuations in the earth potential may cause fire or smoke.



REQUIRED

Handling the power cord

- Please use the power cord supplied with this projector. If the supplied power cord does not satisfy requirements of your country's safety standard, and voltage and current for your region, make sure to use the power cord that conforms to and satisfies them.

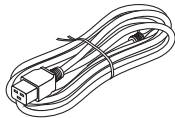

- The power cord you use must be approved by and comply with the safety standards of your country. Please refer to the page 95 about the power cord specification.
For selecting an appropriate power cord, please check rated voltage for your region by yourself.



PROHIBITED

- The power cord included with this projector is exclusively for use with this projector. For safety, do not use it with other devices.

Continue to next page

 **WARNING**



**HAZARDOUS
VOLTAGE**



**DO NOT TOUCH
WITH WET
HANDS**

- Handle the power cord with care. Damaging the cord could lead to fire or electric shock.
 - Do not place heavy objects on the cord.
 - Do not place the cord under the projector.
 - Do not cover the cord with a rug, etc.
 - Do not scratch or modify the cord.
 - Do not bend, twist or pull the cord with excessive force.
 - Do not apply heat to the cord.
- Should the cord be damaged (exposed core wires, broken wires, etc.), ask your dealer to replace it.
- Do not touch the power plug should you hear thunder. Doing so could result in electric shock.
- Do not connect or disconnect the power cord with wet hands. Doing so could result in electric shock.

Installation



PROHIBITED









DO NOT WET









**UNPLUG THE
POWER CORD**







Do not use in places such as those described below.

- Do not use in places such as those described below. Doing so could lead to fire or electric shock.
 - Shaky tables, inclined surfaces or other unstable places.
 - Poorly ventilated spaces.
 - Near a radiator, other heat sources, or in direct sunshine.
 - Continual vibration areas.
 - Humid, dusty, steamy, or oily areas.
 - An environment where there are corrosive gases (sulfur dioxide, hydrogen sulfide, nitrogen dioxide, chlorine, ammonia, ozone, etc.).
 - Outdoors.
 - High-temperature environment where humidity changes rapidly and condensation is likely to occur.
 - Do not use in places such as those described below where the projector could get wet. Doing so could lead to fire or electric shock.
 - Do not use in the rain or snow, on a seashore or waterfront, etc.
 - Do not use in a bathroom or shower room.
 - Do not install under equipment that discharges water, such as air conditioners.
 - Do not place vases or potted plants on the projector.
 - Do not place cups, cosmetics or medicines on the projector.
- Should water, etc. get inside the projector, first turn off the projector's power, then unplug the power cord from the power outlet and contact your dealer.

 WARNING	
 CAUTION	<p>Installing suspended from the ceiling</p> <ul style="list-style-type: none"> • Consult your dealer for installing the projector on the ceiling. Special skills are required for ceiling installation. DO NOT perform installation work by people other than installers. Doing so may result in the projector falling and causing injury. • We are not liable for any accident or/and damage resulting from improper installation or handling, misuse, modification, or natural disasters. • When installed suspended from the ceiling, etc. do not hang from the projector. The projector could drop and cause injury. • When installing suspended from the ceiling, use a power outlet that is within reach so the power cord can be easily plugged and unplugged.
On use	
 PROHIBITED  UNPLUG THE POWER CORD	<p>Do not place objects inside the projector.</p> <ul style="list-style-type: none"> • Do not insert or drop metal or combustible objects or other foreign materials into the projector from the vents. Doing so could lead to fire or electric shock. Be particularly careful if there are children in the home. Should a foreign object get inside the projector, first turn off the projector's power, then unplug the power cord from the power outlet and contact your dealer.
 UNPLUG THE POWER CORD	<p>Unplug the power cord if the projector malfunctions.</p> <ul style="list-style-type: none"> • Should the projector emit smoke or strange odors or sounds, or if the projector has been dropped or the cabinet broken, turn off the projector's power, then unplug the power cord from the power outlet. Otherwise it may cause not only fire or electric shock but also serious damage to your eyesight or burns. Contact your dealer for repairs. Never try to repair the projector on your own. Doing so is dangerous.
 DO NOT DISASSEMBLE	<p>Do not disassemble the projector.</p> <ul style="list-style-type: none"> • Do not remove or open the projector's cabinet. Also, do not modify the projector. There are high voltage areas in the projector. It may cause fire, electric shock, or laser light leakage, resulting in serious damage to your eyesight or burns. Have qualified service personnel perform inspection, adjustments and repairs of the interior.

 WARNING	
<p style="text-align: center;">  PROHIBITED </p> <p style="text-align: center;">  CAUTION FOR HIGH TEMPERATURE </p>	<p>Do not place objects in front of the lens while the projector is operating.</p> <ul style="list-style-type: none"> • Do not leave the lens cap on the lens while the projector is operating. The lens cap could get hot and be warped. • Do not place objects in front of the lens that obstruct the light while the projector is operating. The object could get hot and be broken or catch fire. • The below pictogram indicated on the cabinet means the precaution for avoiding to place objects in front of the projector lens. <p style="text-align: center;">  </p>
<p style="text-align: center;">  PROHIBITED </p>	<p>When cleaning the projector</p> <ul style="list-style-type: none"> • Do not use flammable gas sprays to remove dust from the lens, cabinet, etc. Doing so could lead to fire.
<p style="text-align: center;">  PROHIBITED </p>	<p>Do not use in high security locations.</p> <ul style="list-style-type: none"> • Usage of the product must not be accompanied by fatal risks or dangers that, could lead directly to death, personal injury, severe physical damage or other loss, including nuclear reaction control in nuclear facility, medical life support system, and missile launch control in a weapon system.

 **CAUTION**

Power cord	
 REQUIRED	<p>Handling the power cord</p> <ul style="list-style-type: none"> • The projector should be installed close to an easily accessible power outlet. • When connecting the power cord to the projector's AC IN terminal, make sure the connector is fully and firmly inserted. Loose connection of the power cord could lead to fire or electric shock.
 REQUIRED  UNPLUG THE POWER CORD	<p>Handling the power cord by following below to avoid fire or electric shock</p> <ul style="list-style-type: none"> • When disconnecting the power cord, pull the power cord out by holding onto its plug. • Unplug the power cord from the power outlet before cleaning the product or when not planning to use the product for an extended time. • When the power cord or plug is heat or damaged, unplug the power cord from the power outlet, and contact your dealer.
 REQUIRED	<p>Periodically clean dust and other debris from the power plug</p> <ul style="list-style-type: none"> • Failure to do so could result in fire or electric shock.
 REQUIRED	<p>Disconnect power cords and other cables before moving the projector</p> <ul style="list-style-type: none"> • Before moving the product, make sure the product power is off, then unplug the power cord from the power outlet and check that all cables connecting the product to other devices are disconnected.
 PROHIBITED	<p>Do not use the power cord with a power tap</p> <ul style="list-style-type: none"> • Adding an extension cord may lead to fire as a result of overheating.

 **CAUTION**

Installation



REQUIRED

Securing the lens unit with the fall prevention wire

- If the projector is going to be suspended from a ceiling or another high place, secure the lens unit using the fall prevention wire (sold separately). If the lens unit is not secured, it may fall down if it comes loose.

On use



PROHIBITED

Do not use on networks subject to overvoltage.

- Connect the projector's HDBaseT port and LAN port to a network for which there is no risk of overvoltage being applied. Overvoltage applied to the HDBaseT or LAN port could result in electric shock.



REQUIRED

Lens shift, focus and zoom operations

- When shifting the lens or adjusting the focus or zoom, do so from either behind or the side of the projector. If adjustments are performed from the front, your eyes could be exposed to strong light and get injured.
- Keep your hands away from the lens area when performing the lens shift operation. If not, your fingers could get caught in the gap between the cabinet and the lens.

 **CAUTION**



PROHIBITED

Handling batteries

Incorrect usage of batteries can result in leaks or bursting.

- Use the specified batteries only.
- Insert batteries matching the (+) and (-) signs on each battery to the (+) and (-) signs of the battery compartment.
- Do not mix battery brands.
- Do not combine new and old batteries. This can shorten battery life or cause liquid leakage of batteries.
- Remove dead batteries immediately to prevent battery acid from leaking into the battery compartment.

If leaked battery fluid gets on your skin or clothing, rinse immediately and thoroughly. If it gets into your eye, bathe your eye well rather than rubbing and seek medical treatment immediately. Leaked battery fluid that gets into your eye or your clothing may cause a skin irritation or damage your eye.

- If you will not use the remote control for a long time, remove the batteries.
- Leaving a battery in an extremely high temperature surrounding environment, or a battery subject to extremely low air pressure, that can result in an explosion or the leakage of flammable liquid or gas.
- Properly dispose of depleted batteries. Disposal of a battery into water, fire, or a hot oven, or mechanically crushing, cutting, or modifying a battery can result in an explosion.
- Do not short-circuit the batteries.
- Do not charge the batteries. The batteries provided are not rechargeable.
- Contact your dealer or local authorities when disposing of batteries.









PROHIBITED



**CAUTION
FOR HIGH
TEMPERATURE**

About the vents

- Do not obstruct the projector's vents. Also, do not place such soft objects as paper or cloths underneath the projector. Doing so could lead to fire. Leave sufficient space between the place where the projector is installed and its surroundings. (→ page xxix)
- Do not touch the exhaust vent area while projecting or immediately after projecting images. The exhaust vent area may be hot at this time and touching it could cause burns.

 CAUTION	
 PROHIBITED	<p>Moving the projector</p> <ul style="list-style-type: none"> • After the lens unit removed, have at least two people hold the handles to move the projector. Attempting to move the projector alone could result in back pain or other injuries. • When moving the projector, do not hold anywhere but the handles. Otherwise the projector could fall and cause an injury. • When carrying the projector with the lens unit removed, do not touch the mounting area of the lens with your hands. Also, do not put your hand into the recess of the connection terminal. The projector could be damaged or fall down, resulting in injuries.
 REQUIRED	<p>Attaching/detaching the lens</p> <ul style="list-style-type: none"> • Turn off the projector and disconnect the power cord before attaching or detaching the lens unit. Failure to do so could result in visual impairment or burns. • Do not attach or detach the lens unit with the projector installed in a high location. The lens unit could fall and cause damage or injury.
 PROHIBITED	<p>Do not push or climb on the product. Do not grab or hang onto the product. Do not rub or tap the product with hard objects.</p> <ul style="list-style-type: none"> • The product may fall, causing damage to the product or personal injury.
 REQUIRED	<p>Avoid locations with extreme temperatures and humidity</p> <ul style="list-style-type: none"> • Failure to do so could lead to fire or electric shock or damage to the projector. The usage environment for this projector is as follows: <ul style="list-style-type: none"> - The operating temperature: 0°C to 45°C / 32°F to 113°F / humidity: 20 to 80% (without condensation) - The storage temperature: -10°C to 60°C / 14°F to 140°F / humidity: 20 to 80% (without condensation)
<p>Inspections and Cleaning</p>	
 REQUIRED	<p>Inspecting the projector and cleaning the inside</p> <ul style="list-style-type: none"> • Consult with your dealer about once per year for cleaning of the inside of the projector. Dust could accumulate inside of the projector if it is not cleaned for extended periods of time, leading to fires or malfunction.

Laser Safety Caution

X171Q-B/X171Q-W

WARNING

CLASS 1 LASER PRODUCT [IEC 60825-1:2014]

- The laser module is equipped in this product. Use of controls or adjustments of procedures other than those specified herein may result in hazardous radiation exposure. Laser energy exposure near aperture may cause burns.

- This product is classified as Class 1 of IEC 60825-1:2014.
- For EU and UK, This product complies with EN 60825-1:2014+A11:2021.
- Obey the laws and regulations of your country in relation to the installation and management of the device.

For USA

This product is in conformity with performance standards for laser products under 21 CFR 1040, except with respect to those characteristics authorized by Variance Number FDA-2018-V-4413 effective on September 19, 2023.

X141Q-B/X141Q-W

WARNING

CLASS 1 LASER PRODUCT [IEC 60825-1:2014]

CLASS 1 CONSUMER LASER PRODUCT OF EN 60825-1:2014+A11:2021 (For EU and UK)

- The laser module is equipped in this product. Use of controls or adjustments of procedures other than those specified herein may result in hazardous radiation exposure. Laser energy exposure near aperture may cause burns.

- This product is classified as Class 1 of IEC 60825-1:2014.
- For EU and UK, This product complies with EN 60825-1:2014+A11:2021. This product also complies with EN 50689:2021 except using the lens of XP-62ZL.
- Obey the laws and regulations of your country in relation to the installation and management of the device.

For USA

Complies with 21 CFR 1040.10 and 1040.11 except for conformance as a Risk Group 2 LIP as defined in IEC 62471-5:Ed. 1.0. For more information see Laser Notice No. 57, dated May 8, 2019. However, when using the XP-62ZL lens, the following applies.

This product is in conformity with performance standards for laser products under 21 CFR 1040, except with respect to those characteristics authorized by Variance Number FDA-2018-V-4413 effective on September 19, 2023.

WARNING (For USA)

- Do not allow to look into the projector beam at any distance from the projector. An adult should supervise the children to prevent exposure risks.
- Check that there is no one looking at the lens, when using the remote control for starting the projector.
- Do not look at the projected light using optical devices(binoculars, telescopes, magnifying glasses, reflectors, etc).
- [WARNING: MOUNT ABOVE THE HEADS OF CHILDREN.]
The use of a ceiling mount is recommended with this product to place it above the eyes of children.

-
- Outline of laser emitted from the built-in light module:
 - Wave length: 449 - 461 nm (blue), 635 - 651 nm (red)
 - Maximum power: 456 W (blue), 72 W (red)

Light Module

- A light module containing multiple laser diodes is equipped in the product as the light source.
- These laser diodes are sealed in the light module. No maintenance or service is required for the performance of the light module.
- End user is not allowed to replace the light module.
- Contact qualified distributor for light module replacement and further information.

Risk groups

X171Q-B/X171Q-W

This projector is classified as risk group 3 of IEC/EN 62471-5:2015.

X141Q-B/X141Q-W

This projector is classified as either IEC/EN 62471-5:2015 risk group 2 or risk group 3 depending on the lens unit.

Risk group 2 (RG2)

 **WARNING**

As with any bright light source, do not stare into the beam, RG2 IEC/EN 62471-5:2015.

Risk group 3 (RG3)

 **WARNING**

RG3 PRODUCT OF IEC/EN 62471-5:2015

- When classified as RG3, this projector is for professional use and must be installed in location where safety is assured. For this reason, be sure to consult your dealer as installation must be performed by a professional installer. Never try to install the projector by yourself. This may result in visual impairment etc.
- No direct exposure to the beam shall be permitted, RG3 IEC/EN 62471-5:2015.
- Do not look into the projector's lens. Serious damage to your eyes could result.
- Operators shall control access to the beam within the hazard distance or install the product at the height that will prevent exposures of spectators' eyes within the hazard distance.
- When turning on the power, operate from the side or rear of the projector (outside the hazard zone). Also, when turning on the power, make sure no one within the projection range is looking at the lens.

• Check before installing the projector (For X141Q-B/X141Q-W)

① Lens model name or throw ratio

The lens model name and throw ratio are listed in the image below.

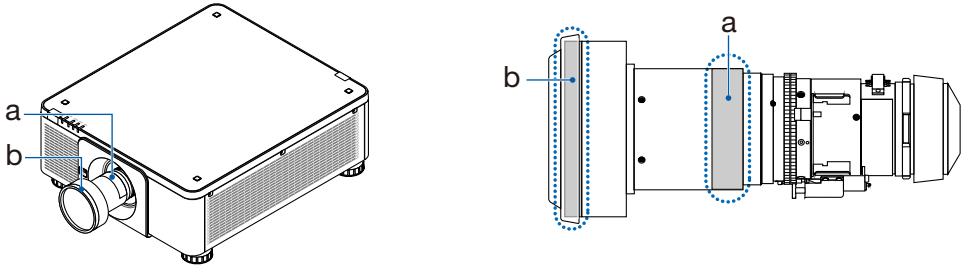

a: Lens model name / b: Throw ratio

② Combining lens units and risk groups

Lens model name	Throw ratio	X141Q-B X141Q-W
XP-57UL	0.31 - 0.33	RG2
XP-58ZL	0.55 - 0.75	
XP-59ZL	0.74 - 1.08	
XP-60ZL	1.05 - 1.41	
XP-61ZL	1.40 - 2.11	
XP-62ZL	2.10 - 4.00	RG3

• Hazard zone

The below figure describes the radiation zone (hazard zone) of light emitted by the projector that is classified as Risk Group 3 (RG3) of IEC/EN 62471-5:2015.

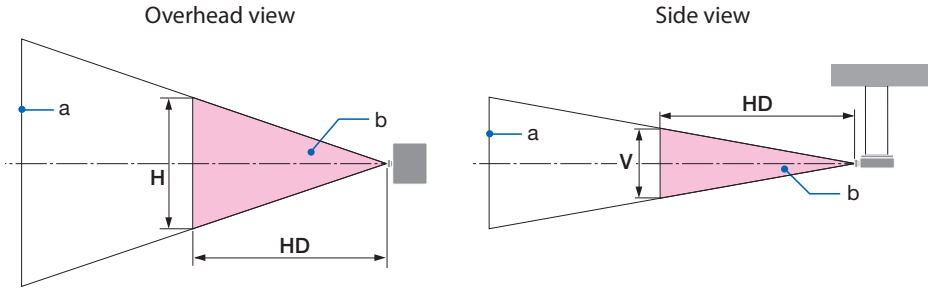

a: Screen / b: Hazard zone

X171Q-B/X171Q-W

Lens	Throw ratio TR@0.8"	Hazard zone (m)		
		HD	H	V
XP-57UL	0.31 (Wide)	0.13	0.41	0.26
	0.33 (Tele)	0.14	0.41	0.26
XP-58ZL	0.55 (Wide)	0.23	0.42	0.26
	0.75 (Tele)	0.40	0.53	0.33
XP-59ZL	0.74 (Wide)	0.33	0.53	0.33
	1.08 (Tele)	0.60	0.60	0.38
XP-60ZL	1.05 (Wide)	0.48	0.54	0.34
	1.41 (Tele)	0.73	0.57	0.35
XP-61ZL	1.40 (Wide)	0.62	0.49	0.31
	2.11 (Tele)	1.16	0.58	0.36
XP-62ZL	2.10 (Wide)	1.18	0.57	0.36
	4.00 (Tele)	2.53	0.66	0.41

X141Q-B/X141Q-W

Lens	Throw ratio TR@0.8"	Hazard zone (m)		
		HD	H	V
XP-62ZL	2.10 (Wide)	-	-	-
	2.12 (Middle)	1.00	0.49	0.31
	4.00 (Tele)	2.11	0.56	0.35

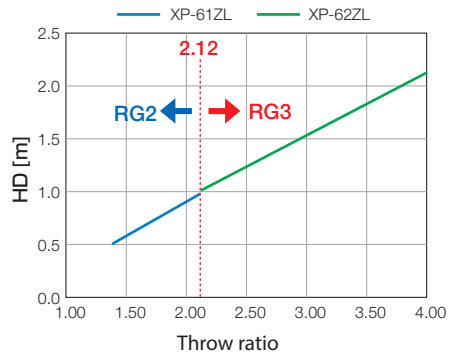

Calculation of the throw ratio

Throw ratio = L: Throw distance (m) / W: Screen width (m)

For throw distances and screen widths, refer to "Lens types and throw distance". (→ page 86, 87)

• About the precautionary zone

By providing a precautionary zone or physical barriers, it is possible to prevent human eyes from entering the hazard zone.

When the manager of the projector (operator) cannot prevent spectators from entering the hazard zone such as in public facilities, it is recommended to secure a space of 1 m or more from the hazard zone as “the precautionary zone” for the safety of the spectators. When installing the projector overhead, it is recommended that the distance between the floor and the hazard zone be at least 3 m in the vertical direction.

In the United States, provide a horizontal distance of 2.5 meters from the hazard zone.

When install the projector overhead, provide a vertical distance of 3 meters from the floor to the hazard zone.

• Installation example considering the precautionary zone (For lens units other than XP-57UL)

① Floor or desktop installation example

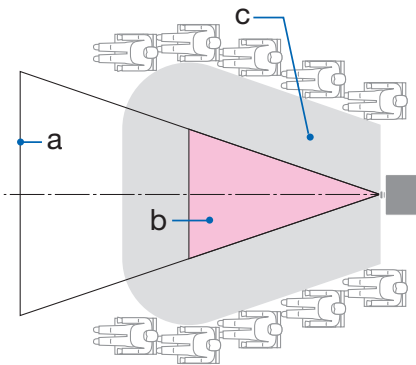

② Ceiling installation example

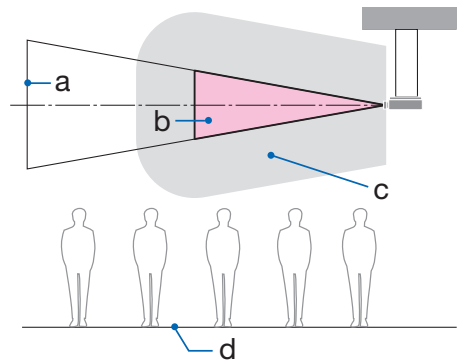

a: Screen / b: Hazard zone / c: Precautionary zone / d: floor

 <p>CAUTION</p>	<p>If it is expected that spectators will intrude into the hazard zone when installed on the ceiling, it is necessary to prevent spectators from entering that area.</p>
---	--

③ **Example of downward projection installed on the ceiling**

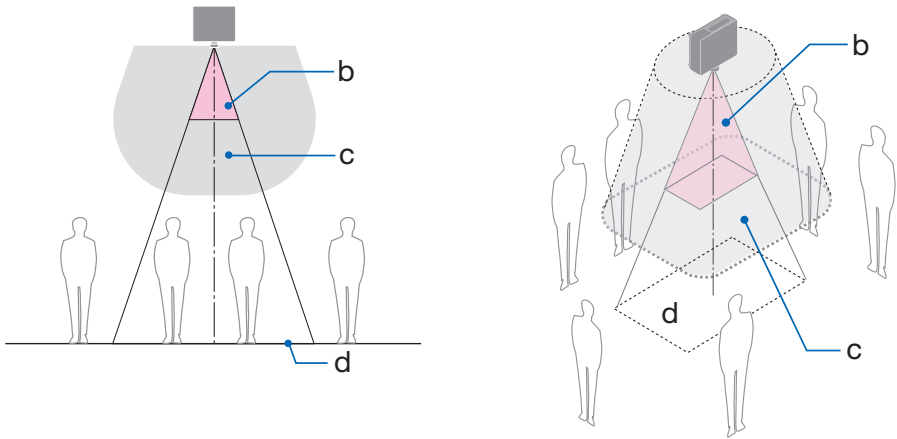

a: Screen / b: Hazard zone / c: Precautionary zone / d: floor

 <p>CAUTION</p>	<p>If the precautionary zone between the floor and the hazard zone cannot be secured, it is necessary to prevent spectators from entering the area around the screen as shown in the figure on the right.</p>
---	---

* If using lens shift, please consider the shift of projected image according to the volume of lens shift. Installation example considering the precautionary zone

• Installation example considering the precautionary zone (For XP-57UL)

① Floor or desktop installation example

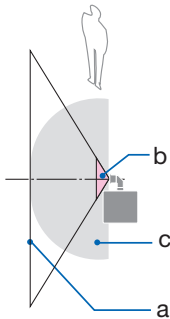

② Ceiling installation example

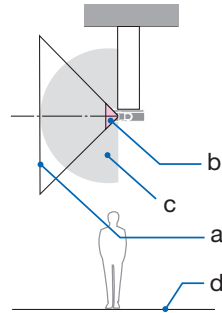

a: Screen / b: Hazard zone / c: Precautionary zone / d: Floor

 <p>CAUTION</p>	<p>If the precautionary zone cannot be secured between the floor and the hazard zone, spectators must be restricted from entering the space between the projector and screen.</p>
---	---

* The above figure is an example of a typical installation. It is also necessary to secure the precautionary zone when installing the projector at an angle.



Please follow all safety precautions.

Installing the projector

- When planning the layout of the projector, make sure to follow the safety measures listed in the installation Manual.
- In order to avoid danger, either install the device within easy reach of a wall outlet or provide a device like a breaker to disconnect power to the projector in emergency.
- Take safety measures to prevent human eyes from entering the hazard zone.
- Select an appropriate lens for the installation location and secure the safety zone set for each lens.
Ensure that appropriate safety measures have been taken when operating the projector, adjusting the light, etc.
- Check whether the appropriate safety zone for the installed lens has been adequately secured. Periodically check the zone and maintain a record of verifications.

The installer or dealer must instruct the manager (operator) of the projector of the following:

- Educate the manager of the projector (operator) about safety before operating the projector.
- Instruct the manager of the projector (operator) to perform inspections (Including safety checks on light emitted by the projector) before powering the projector on.
- Instruct the manager of the projector (operator) to be able to control the projector whenever the projector is powered on in case of an emergency.
- Instruct the manager of the projector (operator) to keep the installation Manual, user's manual and inspection records in an easy-to-reach place.
- Instruct them to determine whether the projector conforms to the standards of each country and region.

Notes on installation and maintenance

Do not install or store in such places as those described below.

- Locations that amplify vibrations and impacts
If installed in places where the vibrations from power sources and the like are conveyed, or in vehicles or on vessels, etc. the projector could be affected by vibrations or shocks that may damage internal parts and lead to malfunction.
- Close to high voltage power lines and power sources
It could disrupt the unit.
- Places where strong magnetic fields are generated
Doing so could lead to malfunction.
- Outdoors and places with humid or dust
Places exposed to oil smoke or steam
Places where corrosive gases are generated
Attached substances such as oil, chemicals and moisture may cause deformation or cracks of the cabinet, corrosion of the metal parts, or malfunction.

To the dealer and the installer

1. To prevent the projector from falling, install it on the ceiling in a way with sufficient strength to withstand the combined weight of the projector and the ceiling mount unit for an extended period of time.
2. When installing the projector on the ceiling, be sure to do so correctly in accordance with the installation Manual for the Ceiling Mount Unit. Be sure to use the fixed metal fittings and to tighten the screws securely.
3. To prevent the projector from falling, use fall prevention wires.
 - Use commercially available metal fittings to join the robust part of a building or construction and the security bar of the projector with the fall prevention wires.
 - Use commercially available metal fittings and fall prevention wires that have sufficient strength to withstand the combined weight of the projector and the ceiling mount unit.
 - Slightly slack off the fall prevention wires so as not to put a load on the projector.
 - Refer to the "Part Names of the Projector" for the location of the security bar. (→ page 6)

Securing personal information

Personally identifiable information, such as IP addresses, may be saved on the projector.

Before transferring or disposing of the projector, clear this data by performing [RESET] on the on-screen menu.

For items that cannot be reset, please clear them individually.

Cautions for ensuring the projector's performance

- If intense light like laser beams enters from the lens, it could lead to malfunction.
- Consult your dealer before using in places where much cigarette smoke or dust is present.
- When the projector is used at high altitudes (places where the atmospheric pressure is low), it may be necessary to replace the optical parts sooner than usual.
- About moving the projector
 - Detach the lens unit once, and be sure to attach the lens cap so as not to scratch the lens. Also, attach a dust protective cap to the projector.
 - Do not subject the projector to vibrations or strong shocks.
The projector could be damaged otherwise.
- Do not use the tilt feet for purposes other than adjusting the projector's tilt. Improper handling, such as carrying the projector by the tilt feet or using it leaned against a wall, could lead to malfunction.
- Do not touch the surface of the projection lens with bare hands. Fingerprints or dirt on the surface of the projection lens will be enlarged and projected on the screen. Do not touch the surface of the projection lens.
- Do not unplug the power cord from the projector or the power outlet while projecting. Doing so could cause deterioration of the projector's AC IN terminal or power plug contact. To interrupt the AC power supply while images are being projected, use a breaker, etc.
- About handling of the remote control
 - The remote control will not work if the projector's remote signal sensor or the remote control's signal transmitter is exposed to strong light or if there are obstacles between them that obstruct the signals.
 - Operate the remote control from within 7 meters from the projector, pointing it at the projector's remote signal sensor.
 - Do not drop the remote control or handle it improperly.
 - Do not let water or other liquids get on the remote control. Should the remote control get wet, wipe it off immediately.
 - Avoid using in hot and humid places as far as possible.
- Take measures to prevent external light from shining on the screen. Make sure only the light from the projector shines on the screen. The less external light on the screen, the higher the contrast and the more beautiful the images.
- About screens
 - Images will not be clear if there is dirt, scratches, discoloration, etc. on your screen. Handle the screen with care, protecting it from volatile substances, scratches and dirt.

Clearance for Installing the Projector

- When installing the projector, keep sufficient space around it, as described below. If not, the hot exhaust emitted from the projector may be taken back in. Also, make sure no wind from an air-conditioner hits the projector. The projector's heat control system may detect an abnormality (temperature error) and automatically shut off the power.

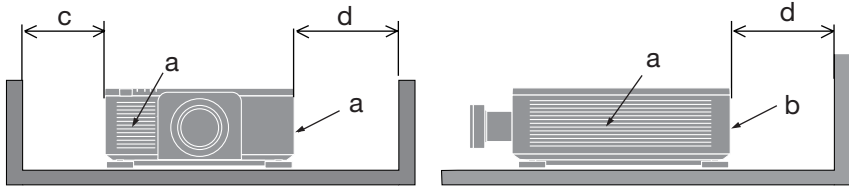

a: Intake vent / b: Exhaust vent / c: 30 cm/12" or greater / d: 50 cm/20" or greater

NOTE:

- In the above figure, it is assumed that there is sufficient space above the projector.
- When using multiple projectors together for multi-screen projection, provide sufficient space around the projectors for air intake and exhaust. When the intake and exhaust vents are obstructed, the temperature inside the projector will rise and this may result in a malfunction.



About Copyright of original projected pictures:

Please note that using this projector for the purpose of commercial gain or the attraction of public attention in a venue such as a coffee shop or hotel and employing compression or expansion of the screen image with the following functions may raise concern about the infringement of copyrights which are protected by copyright law.

[ASPECT RATIO], [KEYSTONE], Magnifying feature and other similar features.

REGISTER YOUR PROJECTOR! (for residents in the United States and Mexico)

Please take time to register your new projector. This will activate your limited parts and labor warranty and InstaCare service program.

Visit our website at <https://www.sharpnecdisplays.us/product-registration> and submit your completed form online.

Upon receipt, we will send a confirmation letter with all the details you will need to take advantage of fast, reliable warranty and service programs from the industry leader, Sharp Imaging and Information Company of America.

Trademarks

- ProAssist is trademark or registered trademark of Sharp NEC Display Solutions, Ltd. in Japan, in the United State and other countries.
- The terms HDMI, HDMI High-Definition Multimedia Interface, HDMI Trade dress and the HDMI Logos are trademarks or registered trademarks of HDMI Licensing Administrator, Inc.
- HDBaseT™ and the HDBaseT Alliance logo are trademarks of the HDBaseT Alliance.
- DisplayPort™ and the DisplayPort™ logo are trademarks owned by the Video Electronics Standards Association (VESA®) in the United States and other countries.
- DLP® and the DLP logo are trademarks or registered trademarks of Texas Instruments in the United States and other countries.
- Trademark PJLink is a trademark applied for trademark rights in Japan, the United States of America and other countries and areas.
- Blu-ray is a trademark of Blu-ray Disc Association.
- Crestron™ and Crestron Connected™ are trademarks or registered trademarks of Crestron Electronics, Inc. in the United States and other countries.
- Other product and company names mentioned in this user's manual may be the trademarks or registered trademarks of their respective holders.

1. Check the product overview, supplied items and part names

1-1. Introduction to the Projector

This section introduces you to your new projector and describes the features and controls.

- **Single-chip DLP projector with high resolution and high brightness**

Realized to project the image in the resolution 3840 × 2400 pixels (4K), the aspect ratio in 16:10.

Model name	Brightness
X171Q-B/X171Q-W	16500 lm (100 - 130 VAC: 14000 lm)
X141Q-B/X141Q-W	13500 lm

- **A proprietary sealed structure that achieves highly dust-proof performance**

Due to its excellent dust-proof performance, the projector is not equipped with a filter. Filter replacement is therefore unnecessary.

- **A long-life laser diode is equipped in the light module**

The laser light source has a long service life, so replacement, adjustment, and other maintenance should not be necessary for an extended period of time.

- **Wide range of optional lenses selectable according to the place of installation**

This projector supports 6 types of optional lenses, providing a selection of lenses adapted to a variety of places of installation and projection methods.

Note that no lens is mounted upon shipment from the factory. Please purchase optional lenses separately.

- **360 degree free projection**

The projector is equipped with a “tilt-free” function for 360° projection vertically and a “roll-free” function for 360° projection horizontally.

- **Power lens control for quick and easy adjustment**

By using buttons on the projector or the remote control, zoom, focus, and position (lens shift) can be adjusted.

- **A variety of input terminals such as HDMI, DisplayPort, HDBaseT, SDI, etc.**

The projector is equipped with HDMI (1/2), DisplayPort (1/2), HDBaseT, SDI (IN/OUT) input terminals.

The projector’s HDMI input terminals and DisplayPort input terminals support HDCP.

HDBaseT, promoted and advanced by the HDBaseT Alliance, is a consumer electronic (CE) and commercial connectivity technology.

- **Multi-screen projection using multiple projectors**

You can line up multiple projectors to display a high resolution image in a larger screen.

Furthermore, the boundaries of the screens are smoothed using an edge blending function.

- **Supports wired LAN**

Equips the LAN and HDBaseT ports. Utilizing a wired LAN connected with these ports, it enables to control the projector by a computer.

1. Check the product overview, supplied items and part names

- **Convenient utility software (User Supportware)**

This projector supports our utility software.

NaViSet Administrator 2 helps you control the projector by a computer via wired LAN connection.

ProAssist is software allowing you for example to control the projector's lens from the computer connected to the projector by a LAN cable. Some of the functions in ProAssist may not be compatible with the projector.

Please visit our website for downloading each software.

URL: <https://www.sharp-nec-displays.com/dl/en/index.html>

- **Crestron Connected compatibility**

The projector supports Crestron Connected, allowing multiple devices connected in the network to be managed and controlled from a computer.

For details, refer to the Crestron Electronics, Inc. website.

<https://www.crestron.com/>

* The projector does not support XiO Cloud.

1. Check the product overview, supplied items and part names

1-2. What's in the Box?

Make sure your box contains everything listed. If any pieces are missing, contact your dealer. Please save the original box and packing materials if you ever need to ship your projector.

Projector

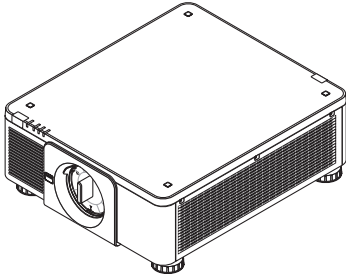

Dust cap for lens

* The projector is shipped without a lens.

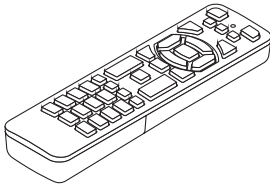

Remote control

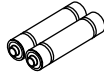

AAA alkaline batteries (x2)



4 Stacking holders

[X171Q-B/X171Q-W] Power cord (x 3)

[X141Q-B/X141Q-W] Power cord (x 2)

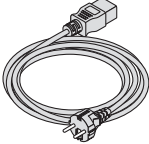
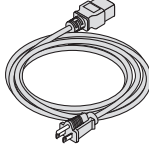
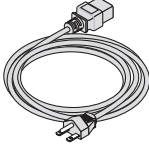
		[X171Q-B/X171Q-W only] 
For Europe/Asia/South America	(for AC 120 V)	(for AC 200 V)
	For North America	

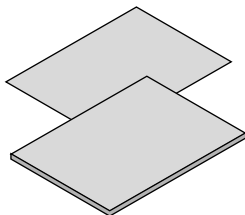

- Important Information
- Quick Setup Guide

For USA only

Limited warranty

For customers in Europe

You will find our current valid Guarantee Policy on our website:

<https://www.sharpnecdisplays.eu>

1-3. Part Names of the Projector

Front

The lens is sold separately. The description below is for when the XP-61ZL lens is mounted.

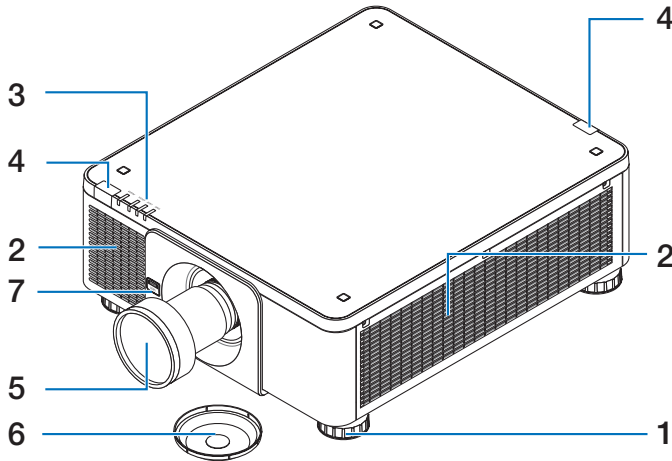

1. Adjustable Tilt Foot

Rotate the tilt foot to adjust the left/right orientation.

2. Intake vent

Takes in outside air to cool the unit.

3. Indicator Section

The indicator light turns on or blinks to relay the status of the projector (Power ON/ Standby/etc.) (→ page 7, 105)

4. Remote Sensor

This part receives signals from the remote control. There are two locations on the front and back of the projector.

5. Lens

Images are projected from here. (Lens unit sold separately.)

6. Lens Cap

(The optional lens is shipped with the lens cap.)

7. Lens Release (LENS) Button

This is used to remove the lens unit.

1. Check the product overview, supplied items and part names

Rear

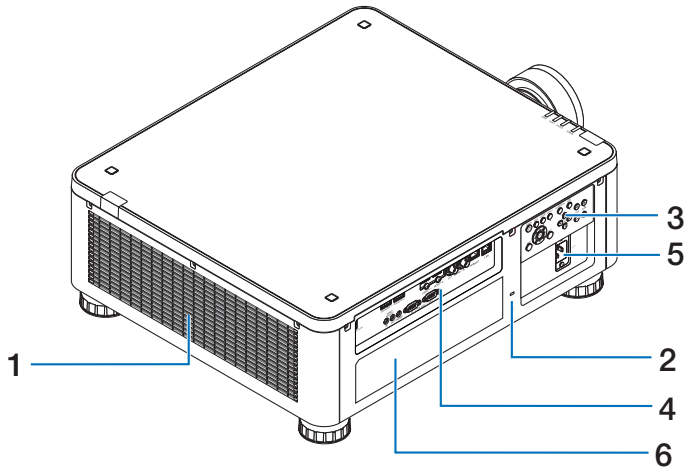

1. Exhaust vent

Heated air is exhausted from here.

2. Security Slot (K)*

This is used when attaching an anti-theft cable.

3. Controls

The projector's power can be turned ON/OFF, and the signal for the projected image can be switched here.

4. Terminals

Connect the cables for the various video signals.

5. AC IN Terminal

Connect the supplied power cord's three-pin plug here, and plug the other end into an active wall outlet.

6. Label

* Security and theft protection lock compatible with Kensington security cables/equipment. For products, visit Kensington's website.

1. Check the product overview, supplied items and part names

Bottom

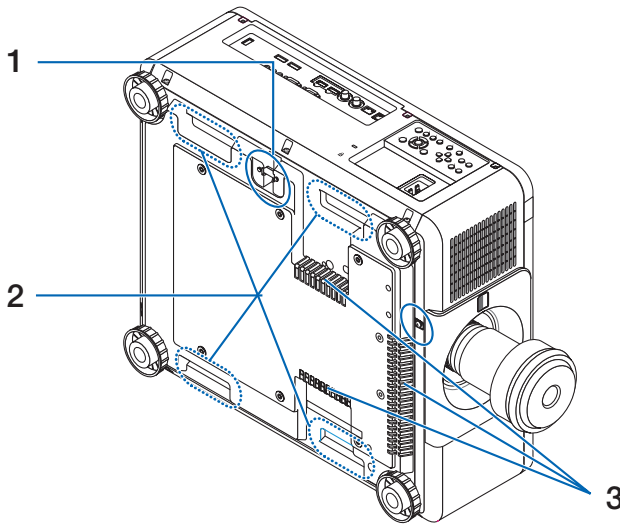

1. Security Bar

Attach an anti-theft device. The security bar accepts security wires or chains up to 0.18 inch/4.6 mm in diameter.

2. Handle (located on 4 positions)

For transportation.

3. Intake vent

Takes in outside air to cool the unit.

CAUTION:

For moving the projector, make sure you have at least two people. At the same time, do not grip and hold the projector other than by these handles. Attempting to move the projector alone could result in back pain or other injuries.

1. Check the product overview, supplied items and part names

Controls/Indicators

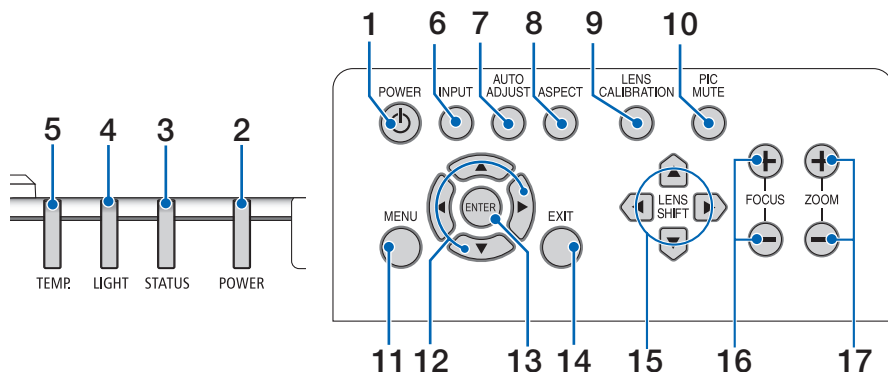

1. (POWER) Button

Switches between projector's power on and standby.

When turning off the power (standby), pressing the button once will bring up a confirmation message on the screen, so press the button one more time.

2. POWER Indicator

Indicates the projector's power state. The indicator lights up in green when the power is on. Depending on the state of power, it will light up or blink in either red or orange when power is off. Refer to the "Indicator Message" section for details.

(→ page 105)

3. STATUS Indicator

This lights up or blinks when an operation button is pressed while the unit is in key lock mode, while the lens is calibrating, etc. Refer to the "Indicator Message" section for details.

(→ page 105)

4. LIGHT Indicator

Indicates the state of the light source.

5. TEMP. Indicator

Indicates high temperatures around the projector.

6. INPUT Button

Selects the input signal. Pressing it quickly will display the input selection screen. Pressing it for one second or longer will begin a series of automatic checks in the order of HDMI1 → HDMI2 → DisplayPort1 → DisplayPort2 → HDBaseT → SDI, and if an input signal is detected then that signal will be projected.

7. AUTO ADJUST Button

Automatically adjusts the projected image to the optimal condition.

8. ASPECT Button

This switches the aspect ratio each time it is pressed.

9. LENS CALIBRATION Button

The lens unit and lens shift adjustment range are calibrated and the lens is shifted back to the home position.

1. Check the product overview, supplied items and part names

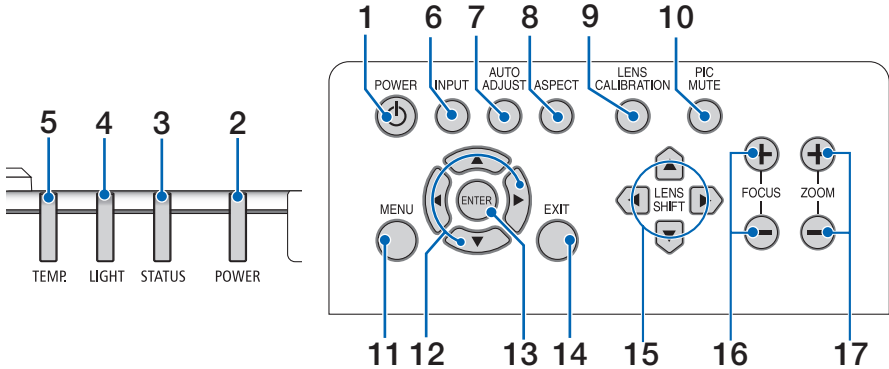

10. PIC MUTE Button

Turns off the image for a short period of time. Press the button again to unmute.

11. MENU Button

Displays the on-screen menu for various settings and adjustments.

12. ▲▼◀▶ Buttons

- When the on-screen menu is displayed, use the ▼▲◀▶ buttons to select the item that you wish to set or adjust.
- Changes the pattern when the test pattern is displayed.

13. ENTER Button

Moves to the next menu when the on-screen menu is displayed. Confirms the item when the confirmation message is displayed.

14. EXIT Button

Close the menu when the on-screen menu is displayed.

Cancels the operation when the confirmation message is displayed.

15. SHIFT Button

Adjust the position of the projected image.

16. FOCUS Button

Adjust the focus of the projected image.

17. ZOOM Button

Adjust the size of the projected image.

1. Check the product overview, supplied items and part names

Terminal Panel Features

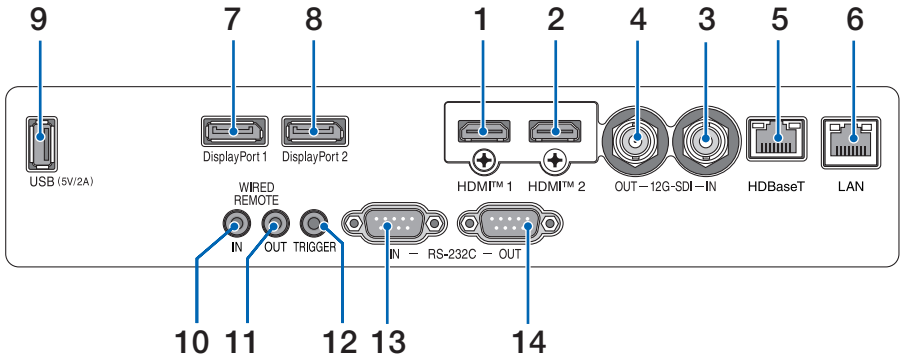

1. HDMI 1 Terminal (Type A)

Connects to the output terminals of a computer, blu-ray player, etc.

2. HDMI 2 Terminal (Type A)

Connects to the output terminals of a computer, blu-ray player, etc.

3. SDI IN Terminal (BNC)

Connects to the SDI output terminal on the video device.

4. SDI OUT Terminal (BNC)

Outputs the video signal input to the SDI IN terminal.

5. HDBaseT Port (RJ-45)

Connects to a commercially available HDBaseT compatible transmission devices.

6. LAN Port (RJ-45)

Connects the unit to a wired LAN.

7. DisplayPort 1 Terminal

Connects to the DisplayPort output terminal on a computer, etc.

8. DisplayPort 2 Terminal

Connects to the DisplayPort output terminal on a computer, etc.

9. USB Port (Type A)

Supplies a 5.0V/2.0A power source when the projector's power is turned on.

10. WIRED REMOTE IN Terminal (Stereo Mini)

Use this terminal for wired remote control of the projector.

NOTE:

- When a remote control cable is connected to the REMOTE terminal, infrared remote control operations cannot be performed.

1. Check the product overview, supplied items and part names

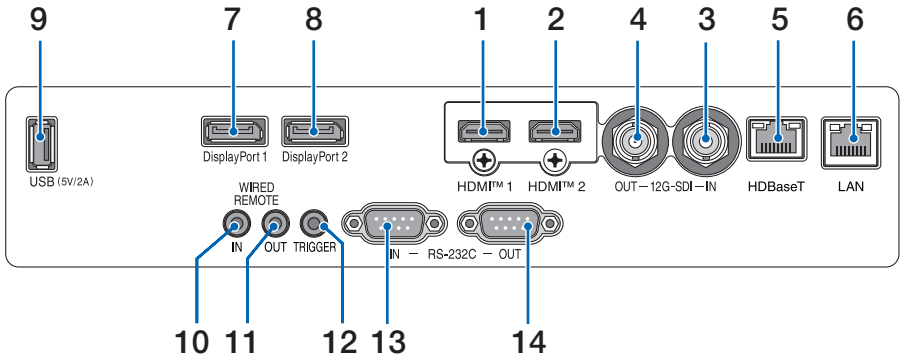

11. WIRED REMOTE OUT Terminal

Outputs the video signal input to the WIRED REMOTE IN terminal.

12. TRIGGER Terminal

When the projector's power is turned on, outputs a control voltage for the screen. Connect a screen controller or other device to control such things as the screen height when the projector's power is turned on and off.

13. RS-232C IN Port (D-Sub 9 Pin)

Use this port to connect a PC or control system. This enables you to control the projector using serial communication protocol.

14. RS-232C OUT Port (D-Sub 9 Pin)

Outputs the control signal input to the RS-232C IN port.

1. Check the product overview, supplied items and part names

1-4. Part Names of the Remote Control

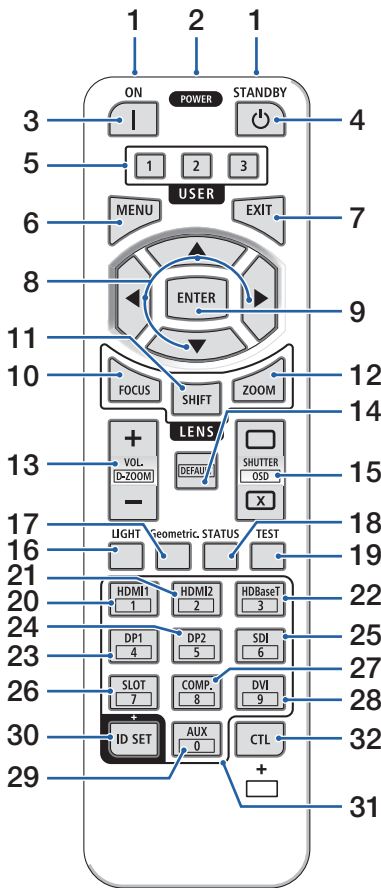

1. Infrared Transmitter

Remote control signals are sent via infrared signal. Point the remote control at the remote control receiver on the projector.

2. Remote Jack

Connect a commercially available remote cable here for wired operation.

3. POWER ON Button (|)

Turns power ON when in standby mode.

4. POWER STANDBY Button (⏻)

Pressing the button once will display the shutdown confirmation message. Press the POWER STANDBY (or ENTER) button once more to power down the projector.

5. USER 1/2/3 Button

USER1: Automatically adjusts the projected image to the optimal condition.

USER2/3: (Not available on this series of projectors.)

6. MENU Button

Displays the on-screen menu for various settings and adjustments.

7. EXIT Button

Closes the menu when the on-screen menu is displayed. Cancels the operation when the confirmation message is displayed.

8. ▲▼◀▶ Button

- When the on-screen menu is displayed, use the ▼▲◀▶ buttons to select the item that you wish to set or adjust.
- Changes the pattern when the test pattern is displayed.

9. ENTER Button

Moves to the next menu when the on-screen menu is displayed. Confirms the item when the confirmation message is displayed.

1. Check the product overview, supplied items and part names

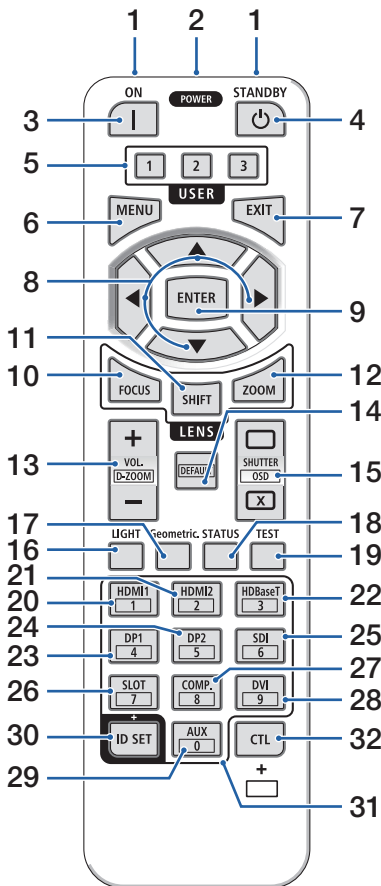

10. FOCUS Button

Opens the focus adjustment screen. Adjust the focus (of the lens) with the ◀ / ▶ buttons.

11. SHIFT Button

The lens shift adjustment screen will be displayed. Use the ▼▲◀▶ buttons to adjust the lens position.

12. ZOOM Button

Opens the zoom adjustment screen. Adjust zoom with the ▼▲ buttons.

13. VOL./D-ZOOM (+)(-) Button

Simultaneously pressing the CTL button will expand or shrink the image (return to the original state).

14. DEFAULT Button

(Not available on this series of projectors.)

15. SHUTTER/OSD OPEN (□)/CLOSE (X) Button

Press the CLOSE button to turn off the light source and temporarily stop projection. Press the OPEN button to resume. Simultaneously press the CTL and CLOSE buttons to close the on-screen display (On-Screen Mute). Simultaneously press the CTL and OPEN buttons to go back.

16. LIGHT Button

This switches [REF. LIGHT MODE] each time it is pressed.

17. Geometric. Button

Displays [DISPLAY] from the on-screen menu.

18. STATUS Button

Displays [INFO.] from the on-screen menu.

19. TEST Button

Projects a test pattern.

20. HDMI1 Button

Selects the HDMI1 input.

21. HDMI2 Button

Selects the HDMI2 input.

1. Check the product overview, supplied items and part names

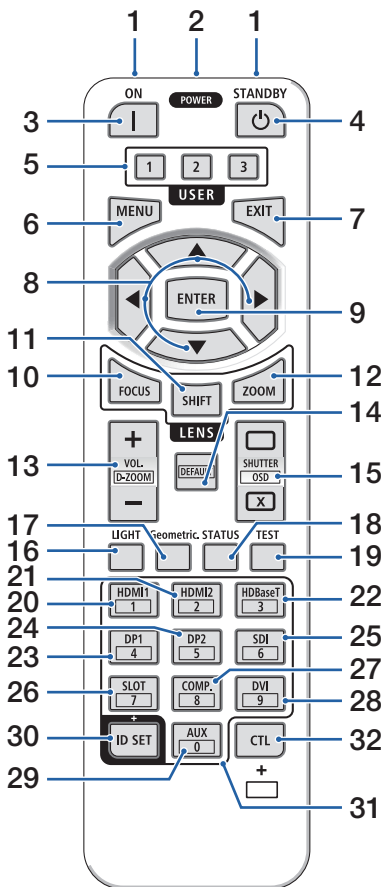

22. HDBaseT Button

Selects the HDBaseT input.

23. DP1 Button

Selects the DisplayPort1 input.

24. DP2 Button

Selects the DisplayPort2 input.

25. SDI Button

Selects the SDI input.

26. SLOT Button

(Not available on this series of projectors.)

27. COMP. Button

(Not available on this series of projectors.)

28. DVI Button

(Not available on this series of projectors.)

29. AUX Button

(Not available on this series of projectors. For future expansion)

30. ID SET Button

Used to set the control ID when performing individual operations on multiple projectors using the remote control.

31. Numeric Keypad Button

Used to input the control ID when performing individual operations on multiple projectors using the remote control (set the control ID). Pressing the 0 button while holding down the ID SET button will remove any control ID settings.

32. CTL Button

This is a multipurpose button for combined use with other buttons.

Battery Installation

1. Press the catch and remove the battery cover.

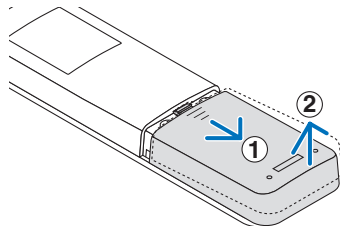

2. Install AAA alkaline batteries. Ensure that you have the batteries' polarity (+/-) aligned correctly.

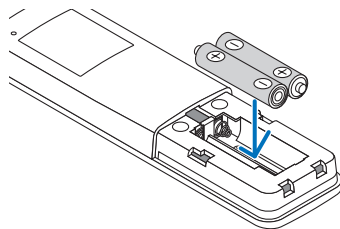

3. Slip the cover back over the batteries until it snaps into place.

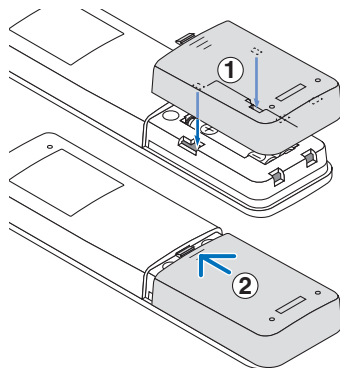

NOTE:

- When replacing the batteries, purchase 2 of the same type of AAA alkaline batteries.
-

Remote Control Precautions

- Handle the remote control carefully.
- If the remote control gets wet, wipe it dry immediately.
- Avoid excessive heat and humidity.
- Do not short, heat, or take apart batteries.
- Do not throw batteries into fire.
- If you will not be using the remote control for a long time, remove the batteries.
- Ensure that you have the batteries' polarity (+/-) aligned correctly.
- Do not use new and old batteries together, or use different types of batteries together.
- Dispose of used batteries according to your local regulations.
- Please note that if multiple projectors are installed nearby, other projectors may unintentionally light up when you turn on the power using the remote control.

1. Check the product overview, supplied items and part names

Operating Range for Wireless Remote Control

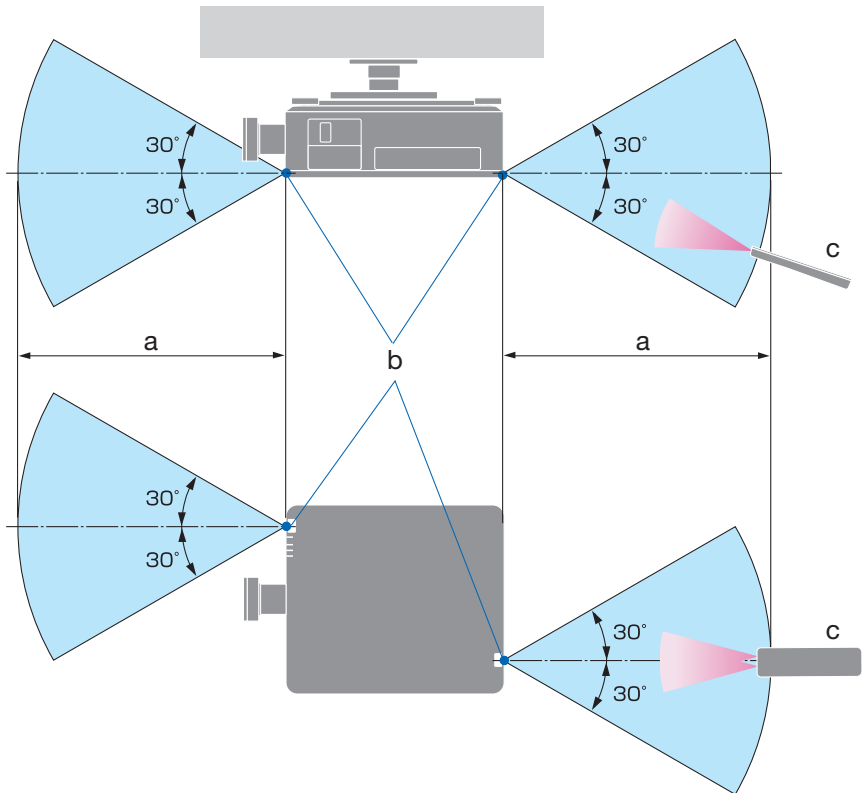

a: 7 m/276" / b: Remote sensor on projector cabinet / c: Remote control

- The projector will not respond if there are objects between the remote control and the sensor, or if strong light falls on the sensor. Weak batteries will also prevent the remote control from properly operating the projector.

1. Check the product overview, supplied items and part names

Using the Remote Control in Wired Operation

Connect one end of the remote cable to the REMOTE terminal and the other end to the remote jack on the remote control.

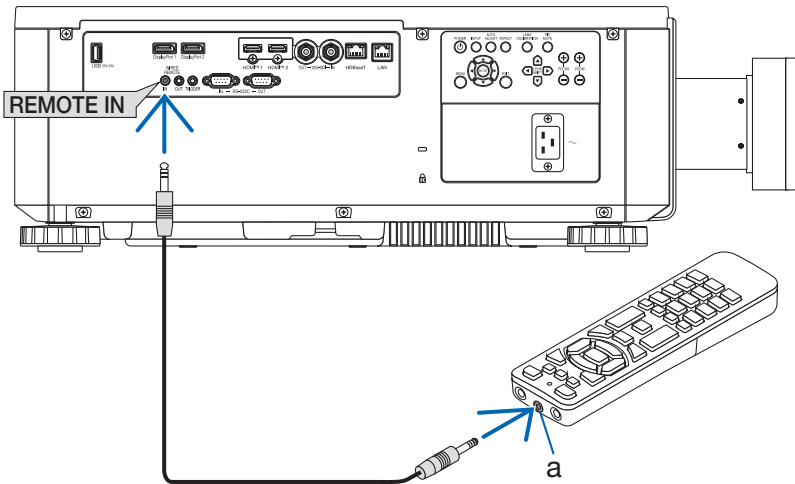

a: Remote jack

NOTE:

- When a remote cable is inserted into the REMOTE terminal, the remote control does not work for infrared wireless communication.
- Power will not be supplied to the remote control by the projector via the REMOTE jack. Battery is needed when the remote control is used in wired operation.

2. Projecting an Image (Basic Operation)

This section describes how to turn on the projector and to project a picture onto the screen.

2-1. Flow of Projecting an Image

Step 1

- **Connecting your computer / Connecting the power cord** (→ [page 18](#))



Step 2

- **Turning on the projector** (→ [page 20](#))



Step 3

- **Selecting a source** (→ [page 23](#))



Step 4

- **Adjusting the picture size and position** (→ [page 24](#))



Step 5

- **Making a presentation**



Step 6

- **Turning off the projector** (→ [page 31](#))



Step 7

- **After use** (→ [page 32](#))

2-2. Connecting Your Computer/Connecting the Power Cord

1. Connect your computer to the projector.

This section will show you a basic connection to a computer.

Connect a commercially available HDMI cable between the computer's HDMI output connector and the projector's HDMI 1 IN or HDMI 2 IN connector.

2. Connect the supplied power cord to the projector.

First connect the supplied power cord's three-pin plug to the AC IN terminal of the projector, and then connect another plug of the supplied power cord directly in the wall outlet. Do not use any plug converter.



CAUTION:

- This equipment is designed to be used in the condition of the power cord connected to earth. If the power cord is not connected to the earth, it may cause electric shock. Please make sure the power cord is connected to the wall outlet directly and earthed properly. Do not use a 2-core plug converter adapter.
- Be sure to connect the projector and the computer (signal source) to the same earth point. If the projector and the computer (signal source) will be connected to different earth points, fluctuations in the earth potential may cause fire or smoke.
- To prevent the power cord from coming loose, make sure that all the prongs of the power cord plug are fully inserted into the AC IN terminal of the projector. A loose contact of the power cord may cause a fire or electric shock.

Upon connecting the power cable, the POWER indicator of the projector will light.

2. Projecting an Image (Basic Operation)

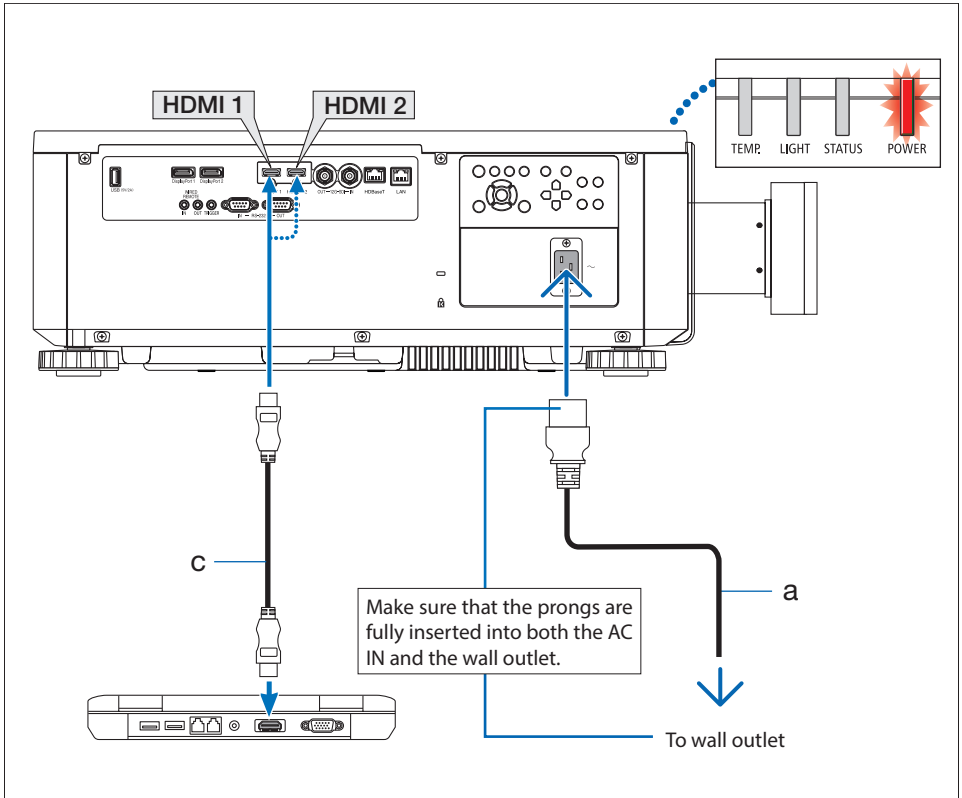

a: Power cord (supplied) / b: HDMI cable (not supplied)

- Use a Premium High Speed HDMI Cable.

CAUTION:

Parts of the projector may become temporarily heated if the projector is turned off with the POWER button or if the AC power supply is disconnected during normal projector operation. Use caution when picking up the projector.

2-3. Turning on the Projector

WARNING

The projector produces a strong light. When turning on the power, operate from the side or rear of the projector (outside the hazard zone). Also, when turning on the power, make sure no one within the projection range is looking at the lens.

1. Remove the lens cap.

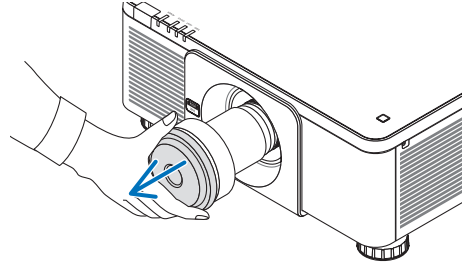

2. Press the (POWER) button on the projector cabinet or the POWER ON button on the remote control.

The POWER indicator lit in red will start to blink in green. After that, the image will be projected onto the screen.

After you turn on your projector, ensure that the computer or video source is turned on.

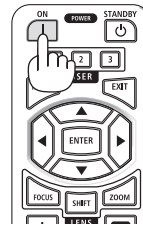

NOTE:

- A blue screen (blue background) is displayed when no signal is being input (by factory default menu settings).

Performing Lens Calibration

After installation or replacement of the lens, be sure to perform [LENS CALIBRATION] by pressing the LENS CALIBRATION button on the projector cabinet. Perform [LENS CALIBRATION] also when trouble is found on the lens shift motion. Calibration corrects the adjustable lens shift range. Also, perform [LENS CALIBRATION] when an error occurs in the lens shift operation.

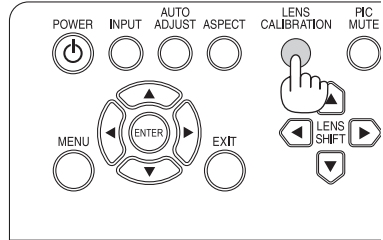

Note on Startup screen (Menu Language Select screen)

When you first turn on the projector, you will get the Startup menu. This menu gives you the opportunity to select one of the 9 menu languages.

To select a menu language, follow these steps:

1. Use the ▲ or ▼ button to select one of the 9 languages from the menu.

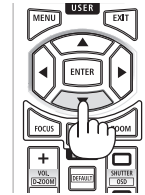
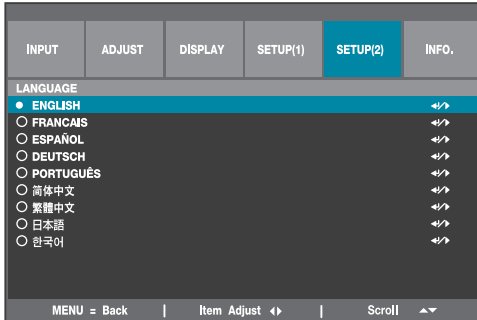

2. Press the ENTER button to execute the selection.

After this has been done, you can proceed to the menu operation.

If you want, you can select the menu language later.

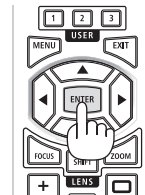

NOTE:

- Keep the lens cap off the lens while the projector's power is on.
If the lens cap is on, it could be warped due to high temperature.
- While the POWER indicator is blinking green in short cycles, the power cannot be turned off by using the power button.
- If the projector is kept in sleep mode or other similar state, the temperature of the internal components could rise even when the projector is being used within its normal operating temperature. If the power is turned on in that state, the cooling fan will turn on and the image will be projected after a short while.

2-4. Selecting a Source

Selecting the computer or video source

NOTE:

- Turn on the computer or video source equipment connected to the projector.

Using the buttons on the projector cabinet

Pressing the INPUT button will switch to the next input source.
HDMI1 → HDMI2 → DisplayPort1 → DisplayPort2 → HDBaseT
→ SDI → HDMI1 → ...

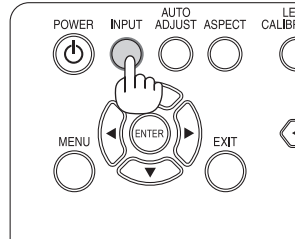

Using the Remote Control

Press the HDMI1 or HDMI2 button.

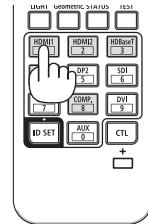

2-5. Adjusting the Picture Size and Position

Use the lens shift, the adjustable tilt foot, the zoom and the focus to adjust the picture size and position.

Repeat these adjustments until you obtain the optimal projection conditions.

In this chapter drawings and cables are omitted for clarity.

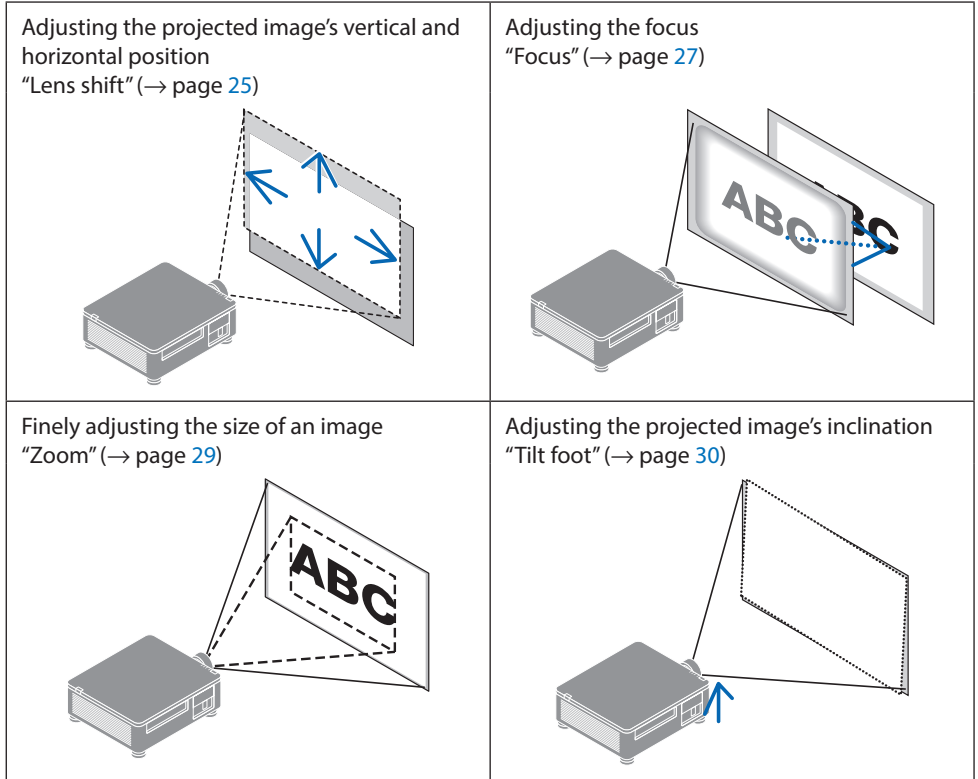

NOTE:

- The SHIFT, FOCUS and ZOOM buttons on the remote control will not function while the test pattern is being projected. When using the remote control, adjust the setting by pressing the MENU button to open the on-screen menu and then selecting [DISPLAY]→[LENS]→[LENS CONTROL].

Adjusting the vertical position of a projected image (Lens shift)

CAUTION

- Perform the adjustment from behind or from the side of the projector. If adjustments are performed from the front, your eyes could be exposed to strong light and get injured.
- Keep hands away from the lens mounting portion while performing a lens shift. Failure to do so could result in fingers being pinched by the moving lens.

Using the buttons on the projector cabinet

1. Press the **LENS SHIFT**     buttons to move the projected image.

Using the Remote Control

1. Press the **SHIFT** button.

The [LENS CONTROL (SHIFT)] screen will be displayed.

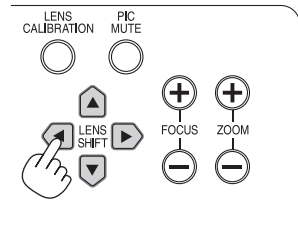

2. Press the     buttons to move the projected image.

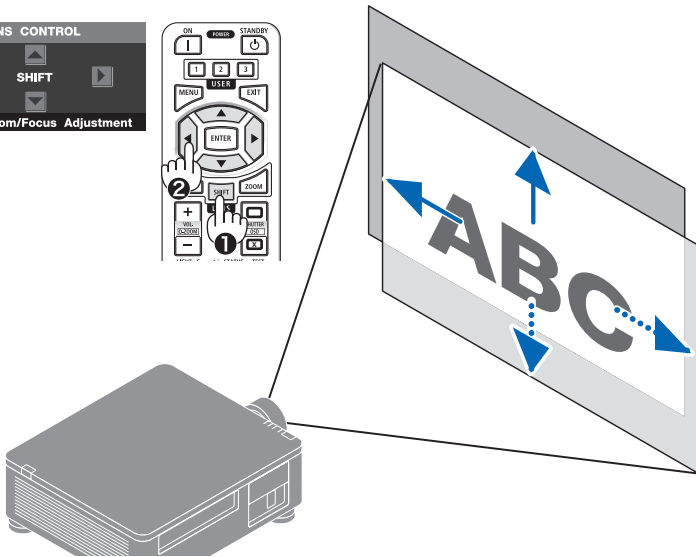
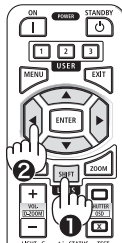

2. Projecting an Image (Basic Operation)

To set back the lens to the home position

Press the LENS CALIBRATION button. The lens mounted on the projector goes back to the home position. (roughly to the center position)

NOTE:

- If the lens is shifted to the maximum in the diagonal direction, the screen peripheral area will be dark or shaded.

TIP:

- The figure below shows the lens shift adjustment range (projection method: Desktop/Front) of the XP-61ZL lens unit.

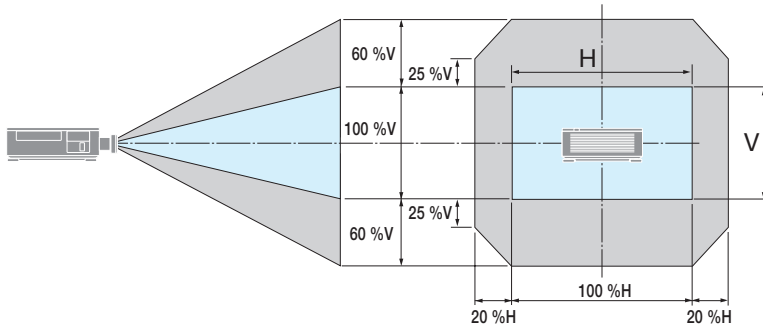

Description of symbols: V indicates vertical (height of the projected image), H indicates horizontal (width of the projected image).

Focus

① Adjust the focus around the optical axis (Powered focus)

Using the buttons on the projector cabinet

1. Press the FOCUS (+) or (-) button to align focus around the optical axis.

- * The picture shows an example when the lens shift is moved upward. Adjust the lens until the bottom edge of the projection screen is in focus.

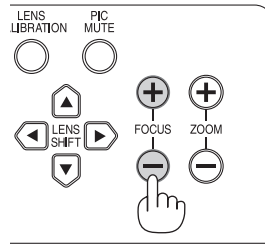

Using the Remote Control

1. Press the FOCUS or ZOOM button.

The [LENS CONTROL (ZOOM/FOCUS)] screen will be displayed on.

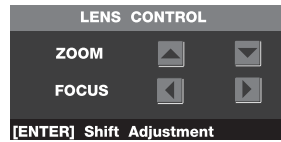

2. Press either ◀ or ▶ button to align focus around the optical axis.

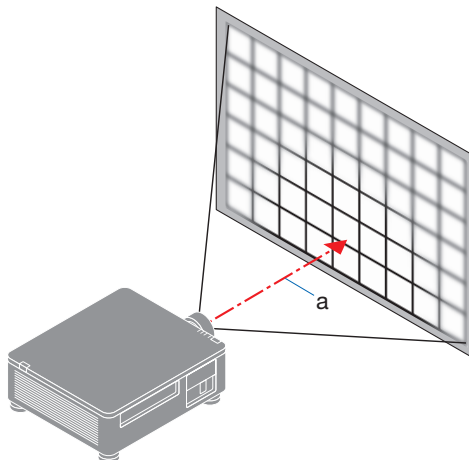
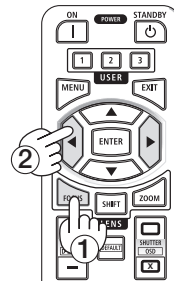

a: Optical axis

2. Projecting an Image (Basic Operation)

② Adjust the focus of screen peripheral area (Manual focus)

Turn the peripheral focus ring clockwise or counterclockwise.

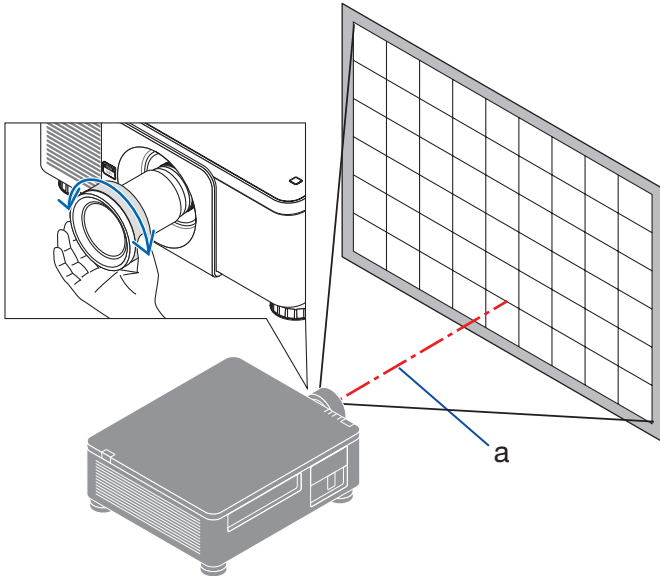

③ Repeat steps ① and ② until the entire projection screen is in focus.

Zoom

Using the buttons on the projector cabinet

1. Press the ZOOM (+) or (-) button to adjust zoom.

Using the Remote Control

1. Press the ZOOM or FOCUS button.

The [LENS CONTROL (ZOOM/FOCUS)] screen will be displayed on.

2. Press **▲▼** button to adjust zoom.

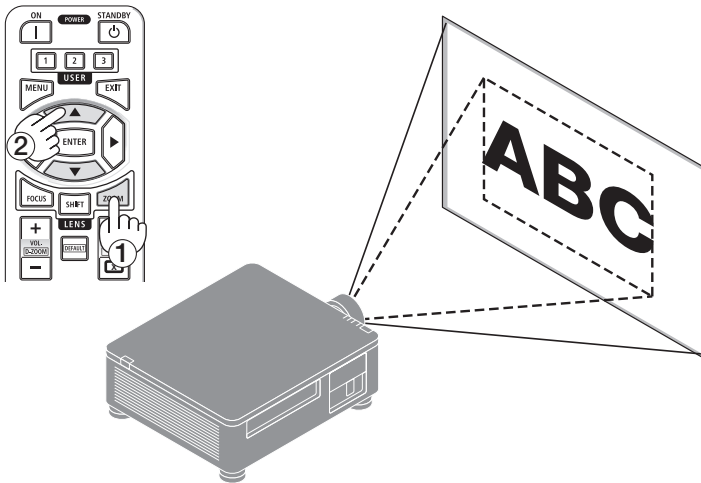
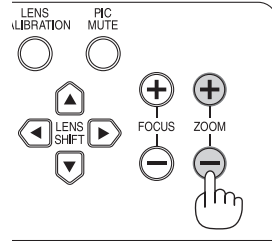
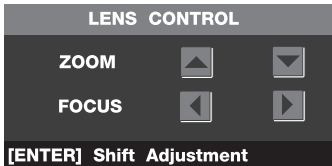

Adjusting the Tilt Foot

1. The position to project image may be adjusted by the tilt foot positioned at four corners of the cabinet bottom.

The tilt foot height can be adjusted by its turn.

"To adjust the height of the projected image"

The height of the projected image is adjusted by turning either front or rear tilt foot.

"If the projected image is tilted"

If the projected image is tilted, turn either left or right tilt foot to adjust the image so that it is level.

- The tilt foot can be lengthened by a maximum of 10 mm.
- The tilt foot can be used to tilt the projector by a maximum of 1°.

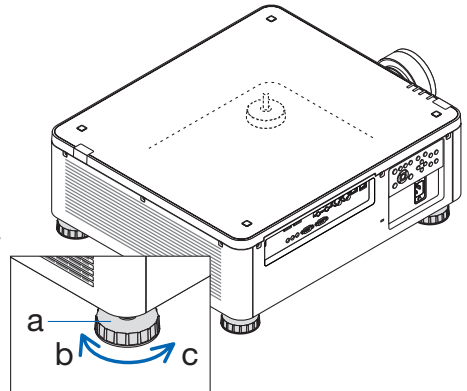
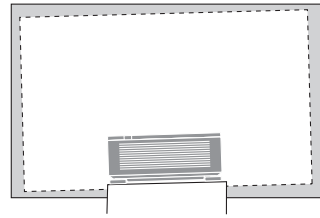

a: Tilt foot / b: Up / c: Down

NOTE:

- Do not lengthen the tilt foot any more than 10 mm/0.4". Doing so will make the projector unstable.
- Pay attention to lengthen or shorten two tilt foot at front at the same time. Same for the rear foot, otherwise, the weight of the projector is loaded on one side and it may cause of damage to it.
- Do not use the tilt foot for any purpose other than adjusting inclination of the projector installation angle. Handling the tilt foot improperly, such as carrying the projector by grasping the tilt foot or hooking it onto a wall using the tilt foot, could damage the projector.

2-6. Turning off the Projector

To turn off the projector:

1. First, press the  (POWER) button on the projector cabinet or the STANDBY button on the remote control.

The [POWER OFF / ARE YOU SURE ?] message will appear.

**POWER OFF
ARE YOU SURE ?**

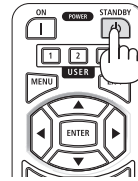

2. Secondly, press the  (POWER) or the STANDBY button again.

The light source will be turned off and the power supply will be cut.



CAUTION

- Parts of the projector may become temporarily heated if the projector is turned off with the POWER button or if the AC power supply is disconnected during normal projector operation. Use caution when picking up the projector.

NOTE:

- While the POWER indicator is blinking green in short cycles, the power cannot be turned off.
- Do not unplug the power cord from the projector or from the power outlet while an image is being projected. Doing so could deteriorate the projector's AC IN terminal or the power plug's contact. To turn off the AC power while an image is being projected, use the breaker, etc.
- Do not disconnect the AC power supply to the projector within 10 seconds of making adjustment or setting changes and closing the menu. Doing so can cause loss of adjustments and settings.

2-7. After Use

1. Unplug the power cord.
2. Disconnect any other cables.
3. Mount the lens cap on the lens.
4. Before moving the projector, screw in the tilt foot if they have been lengthened.

3. Convenient Features

3-1. Turn off the light of the projector (SHUTTER)

1. Press the SHUTTER CLOSE (X) button on the remote control.

The light source will turn off temporarily.

Press the SHUTTER OPEN (□) button to allow the screen to become illuminated again.

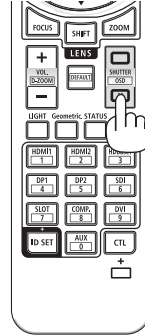

3-2. Turning Off the On-Screen Menu (On-Screen Mute)

1. Hold down the CTL button on the remote control and press the OSD CLOSE (X) button.

The on-screen menu, input terminal, etc. will disappear.

- To display the on-screen display, press the OSD OPEN (□) button while holding down the CTL button on the remote control.

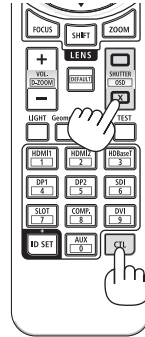

TIP:

- To confirm that the on-screen mute is turned on, press the MENU button. If the on-screen menu is not displayed even though you press the MENU button, it means the on-screen mute is turned on.
- The on-screen mute is maintained even when the projector is turned off.

3-3. Enlarging a Picture

You can enlarge the picture up to four times.

NOTE:

- Depending on an input signal, the maximum magnification may be less than four times, or the function may be restricted.

- 1. Press and hold the CTL button and then press VOL./D-ZOOM (+) button on the remote control to magnify the picture.**

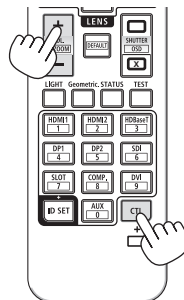
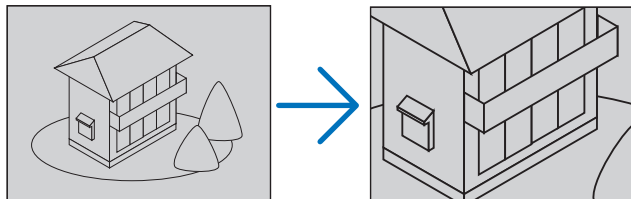

- 2. Press and hold the CTL button and then press VOL./D-ZOOM (-) button on the remote control.**

Each time the button is pressed, the image is reduced.

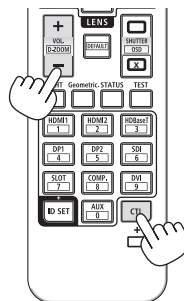

NOTE:

- The image will be enlarged or reduced at the center of the screen.
- The projection area of the enlarged video can be adjusted by going to the on-screen menu and selecting [DISPLAY]→[ZOOM] and then either [HORIZONTAL POSITION] or [VERTICAL POSITION].

3-4. Adjustment of luminance (brightness)

Three [REF. LIGHT MODE] options can be selected according to the purpose of use. Brightness can be adjusted and controlled to maintain a constant brightness after adjustment

NORMAL	This is the standard mode You can adjust the output from 30 to 100%*1 using [REF. LIGHT ADJUST].
ECO	Brightness will be at about 90%*2. The cooling fan will also slow down accordingly. Lower power consumption.
FULL	Brightness changes to 100%*2 and the screen becomes bright.

The brightness will change when using X171Q-B/X171Q-W with 100-130 VAC.

*1: 30 to 85%

*2: about 85%

Change [REF. LIGHT MODE]

1. Press LIGHT button on the remote control.

[REF. LIGHT MODE] switches each time the button is pressed.

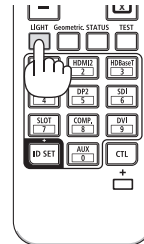

Perform [REF. LIGHT ADJUST]

This can be adjusted when [REF. LIGHT MODE] is set to [NORMAL].

1. Press the MENU button.

The menu will be displayed.

2. Using the ▼▲◀▶ buttons, select [SETUP(1)] → [REF. LIGHT MODE] → [REF. LIGHT ADJUST].

3. Press the ▶ button to adjust.

TIP:

- Setting [CONSTANT BRIGHTNESS] to [ON] will maintain the degree of luminance (brightness) after the light is adjusted.
- The projector's protection functions may temporarily reduce luminance (brightness) in hot operating environments. The TEMP. indicator will light up in orange when the protection functions are active. The temperature inside the projector decreases due to the room temperature being lowered, returning to the original brightness.

3-5. Correcting Horizontal and Vertical Keystone Distortion [KEYSTONE]

Use the [KEYSTONE] feature to correct keystone (trapezoidal) distortion to make the top or bottom and the left or right side of the screen longer or shorter so that the projected image is rectangular.

1. Press the Geometric. button.

Display the [DISPLAY] screen of the on-screen menu.

2. Press the ▼/▲ button to select [GEOMETRIC CORRECTION] and press the ENTER or ► button.

The [GEOMETRIC CORRECTION] screen will be displayed.

3. With the cursor set to [MODE], use the ◀ and ▶ buttons to select [KEYSTONE].

4. Press the ▼/▲ button to select [KEYSTONE] and press the ENTER or ► button.

The [KEYSTONE] menu screen will displayed on.

5. Move the cursor to [H KEYSTONE] or [V KEYSTONE], then press the ◀/▶ button to adjust the projection screen.

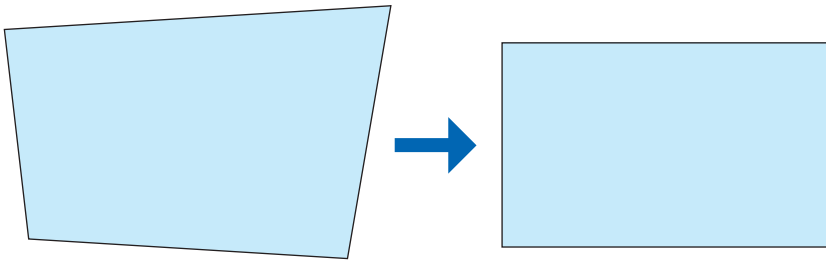

TIP:

- For details on the [GEOMETRIC CORRECTION] menu functions, see (→ page 61).
-

NOTE:

- Using [KEYSTONE] correction can cause the image to be slightly blurred because the correction is made electronically.
 - Use horizontal keystone correction when the vertical lens shift position is near 0V.
Other than the above cases, use [CORNERSTONE] to correct the keystone distortion.
-

3-6. Controlling the Projector by Using an HTTP Browser

Overview

You can display the HTTP server screen of the projector by using a web browser and operating the projector with a computer or smartphone.

Possible operations on the HTTP server screen

- Operate the projector.
Operations such power on/off of the projector, input terminal switchover, and lens control etc. can be carried out.
- Adjusting the picture and projection screen, such as picture adjustment, geometric correction, edge blending, etc. is possible.
- Network settings (smartphones are not supported)
Configure the various settings when using the projector connected to a network (wired LAN). Also, it is possible to configure the connection settings with various control systems.

For details about settings and adjustments, see the explanation on the screen menu.

NOTE:

- When connecting to the HTTP server for the first time after purchasing the projector, be sure to set a password. Please refer to "Setting the login password for the HTTP server screen" (→ page 115) for details on the operation.

To view the HTTP server screen

For computers

1. **Connect the projector to the computer with a LAN cable sold commercially. (→ page 82)**
2. **Select [SETUP(1)] → [NETWORK SETTINGS] → [WIRED LAN] in the on-screen menu to configure the network settings. (→ page 71)**
3. **Start up the web browser on your computer and enter the address or URL in the input field.**

Specify the address or URL as "http://<IP Address of Projector>/index.html".

The HTTP server login screen will be displayed.

4. **Enter the password in the [Password] input field and click the [Login] button.**

The HTTP server screen will be displayed.

For smartphones

1. **Connect a wireless LAN compatible router to the projector with a commercially available LAN cable.**
2. **Select [SETUP(1)] → [NETWORK SETTINGS] → [WIRED LAN] in the on-screen menu to configure the network settings. (→ page 71)**
3. **Configure the network settings of the smartphone so that it can be connected to the projector.**

4. Start up the web browser and enter the address or URL in the input field.

Specify the address or URL as “http://<IP Address of Projector>/index.html”.

The HTTP server login screen will be displayed.

5. Enter the password in the [Password] input field and click the [Login] button.

The HTTP server screen will be displayed.

NOTE:

- To use the projector in a network, consult with your network administrator about network settings.
 - When you enter the password, pay enough attention to people around for the password abuse prevention. If you have anxiety the password is cheated, change the password immediately.
 - The display's or button's response can be slowed down or operation may not be accepted depending the settings of your network. Should this happen, consult your network administrator. The projector may not respond if its buttons are repeatedly pressed in rapid intervals. Should this happen, wait a moment and repeat. If you still can't get any response, turn off and back on the projector.
 - If the PROJECTOR NETWORK SETTINGS screen does not appear in the web browser, press the Ctrl+F5 keys to refresh your web browser (or clear the cache).
 - This projector uses “JavaScript” and “Cookies” and the browser should be set to accept these functions. The setting method will vary depending on the version of browser. Please refer to the help files and the other information provided in your software.
-

Preparation before Use

Connect the projector to a commercially available LAN cable before engaging in browser operations. (→ page 82)

Operation with a browser that uses a proxy server may not be possible depending on the type of proxy server and the setting method. Although the type of proxy server will be a factor, it is possible that items that have actually been set will not be displayed depending on the effectiveness of the cache, and the contents set from the browser may not be reflected in operation. It is recommended that a proxy server not be used unless it is unavoidable.

Handling of the Address for Operation via a Browser

Regarding the actual address that is entered for the address or entered to the URL column when operation of the projector is via a browser, the host name can be used as it is when the host name corresponding to the IP address of the projector has been registered to the domain name server by a network administrator, or the host name corresponding to the IP address of the projector has been set in the “HOSTS” file of the computer being used.

Example 1: When the host name of the projector has been set to “pj.sharp.co.jp”, access is gained to the network setting by specifying
http://pj.sharp.co.jp/index.html
for the address or the entry column of the URL.

Example 2: When the IP address of the projector is “192.168.73.1”, access is gained to the network setting by specifying
http://192.168.73.1/index.html
for the address or the entry column of the URL.

3-7. Storing Changes for Lens Shift [LENS MEMORY]

This function serves to store the adjusted values when using the [LENS SHIFT], [ZOOM], and [FOCUS] functions of the projector. A maximum of 10 values can be stored. The adjusted values stored in memory can be used as a reference to the current.

To store your adjusted values in [LENS MEMORY]:

- 1. Adjust the projection position using the lens shift function of the projector.**
- 2. Press the MENU button.**

The menu will be displayed.
- 3. Press the ◀/▶ button to select [DISPLAY].**
- 4. Press the ▼/▲ button to select [LENS] and press the ENTER or ▶ button.**
- 5. Press the ▼/▲ button to select [LENS MEMORY] and press the ENTER or ▶ button.**

The [LENS MEMORY] screen will be displayed.
- 6. Press the ▼/▲ button to move the cursor to any of the items displayed as [STORE] on the right side in [MEMORY 1] to [MEMORY 10], then press the ENTER or ▶ button.**

The LENS MEMORY registration screen will be displayed.
Enter a memory name if necessary.
- 7. Press the ▼/▲ button to select [Accept] and press the ENTER button.**

The lens shift, zoom and focus adjustment value will be stored in the memory.

To call up your adjusted values from [LENS MEMORY]:

- 1. Press the MENU button.**

The menu will be displayed.
- 2. Press the ◀/▶ button to select [DISPLAY].**
- 3. Press the ▼/▲ button to select [LENS] and press the ENTER or ▶ button.**
- 4. Press the ▼/▲ button to select [LENS MEMORY] and press the ENTER or ▶ button.**

The [LENS MEMORY] screen will be displayed.
- 5. Press the ▼/▲ button to move the cursor to any of the items displayed as [MOVE] on the right side in [MEMORY 1] to [MEMORY 10], then press the ENTER button.**

The adjustment value in the memory will be applied.

NOTE:

- The [LENS MEMORY] function may not produce a completely aligned image (due to tolerances in the lenses) using the adjusted values stored in the projector. After calling up and applying the stored values from the [LENS MEMORY] function, finely adjust the lens shift, motorized zoom and motorized focus to produce the best possible image.
-

To delete your adjusted values from [LENS MEMORY]:

1. Press the MENU button.

The menu will be displayed.

2. Press the ◀/▶ button to select [DISPLAY].

3. Press the ▼/▲ button to select [LENS] and press the ENTER or ▶ button.

4. Press the ▼/▲ button to select [LENS MEMORY] and press the ENTER or ▶ button.

The [LENS MEMORY] screen will be displayed.

5. Press the ▼/▲ button to move the cursor to any of the items displayed as [MOVE] on the right side in [MEMORY 1] to [MEMORY 10], then press the ▶ button.

The display changes from [MOVE] to [RESET].

- The setting switches between [RESET] and [MOVE] each time the ▶ button is pressed.

6. Press the ENTER button.

The adjustment value in the memory will be deleted.

3-8. Adjust boundaries of a projected image [EDGE BLENDING]

This projector is equipped with an "[EDGE BLENDING] Function" that makes the edges (boundaries) of the projection screen indistinguishable.

The following procedure shows an example of four projectors in a 2×2 layout.

Preparation:

- Set up the projectors and connect them to the video output equipment.
- Turn on the power of all devices to project the images.

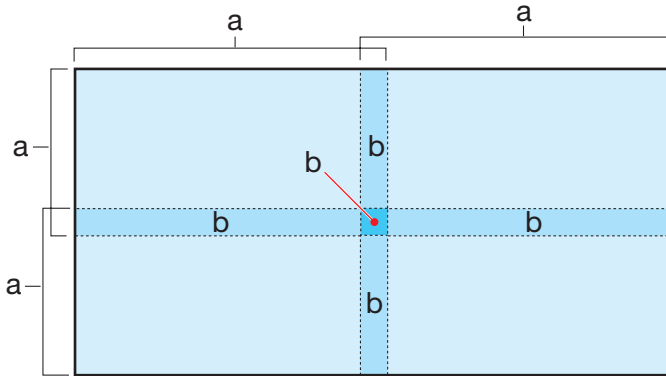

a: Projected area / b: Edge Blending area

NOTE:

- Before performing the Edge Blending function, place the projector in the correct position so that the image becomes square in the appropriate size, and then make optical adjustments (lens shift, focus, and zoom).
- Adjust the brightness of each projector using [REF. LIGHT ADJUST] under [REF. LIGHT MODE]. Also adjust the color tone of each projector using [COLOR CORRECTION].

1. Enable [EDGE BLENDING].

- ① Press the MENU button.
The menu will be displayed.
- ② Press the ◀/▶ button to select [DISPLAY].
- ③ Press the ▼/▲ button to select [EDGE BLENDING] and press the ENTER or ▶ button.
The [EDGE BLENDING] screen will be displayed.
- ④ With the cursor set to [MODE], press the ENTER or ▶ button.
The [MODE] screen will be displayed.
- ⑤ Press the ▼/▲ button to select [ON] and press the ENTER or ▶ button.
This enables the Edge Blending function. The following menu items are available:
[MARKER], [RANGE], [WHITE LEVEL], and [BLACK LEVEL]

2. Display the marker.

- ① Press the ▼/▲ button to select [MARKER] and press the ENTER or ► button.
The [MARKER] screen will be displayed.
- ② Press the ▼/▲ button to select [ON] and press the ENTER or ► button.
The adjustment position for the width of the edge blending area will appear in cyan and the position where edge blending will begin will be indicated by a red marker.

3. Use [WHITE LEVEL] to adjust the width of the edge blending area.

- ① Press the ▼/▲ button to select [WHITE LEVEL] and press the ENTER or ► button.
The [WHITE LEVEL] screen will be displayed.
- ② Press the ▼/▲ button to select the adjustment position, then press the ◀/▶ button to adjust the width of the edge blending area.

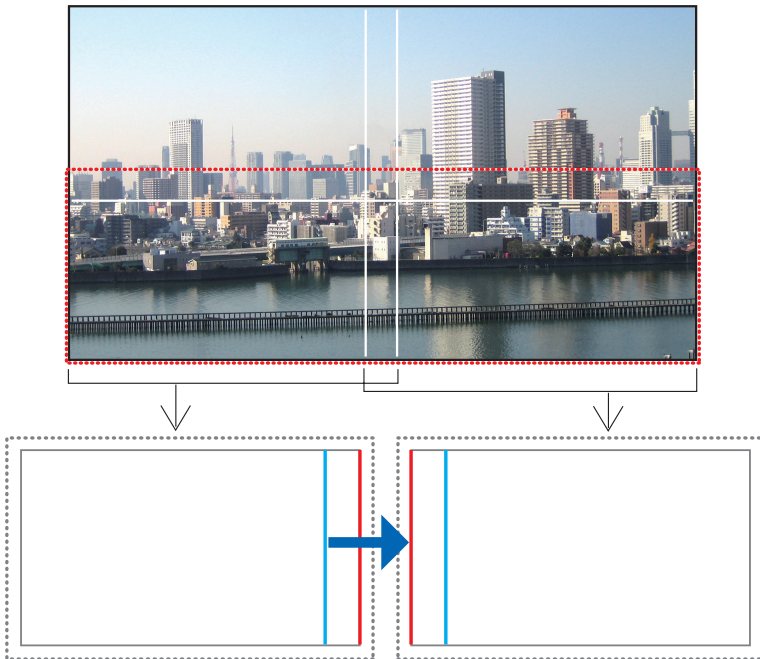

* The 2 screens are separated in the diagram for explanatory purposes.

Adjust the [RIGHT] cyan marker on the right side of the bottom-left screen so that it overlaps the red marker of the bottom-right screen.

4. Hide the marker.

- ① Press the ▼/▲ button to select [MARKER] and press the ENTER or ► button.
The [MARKER] screen will be displayed.
- ② Press the ▼/▲ button to select [OFF] and press the ENTER or ► button.
The marker will be hidden.

5. Use [BLACK LEVEL] to adjust the brightness of images that do not overlap.

- ① Press the ▼/▲ button to select [BLACK LEVEL] and press the ENTER or ► button.
The [BLACK LEVEL] screen will be displayed.
- ② Press the ▼/▲ button to select the adjustment position, then press the ◀/▶ button to adjust the width of the black level range.

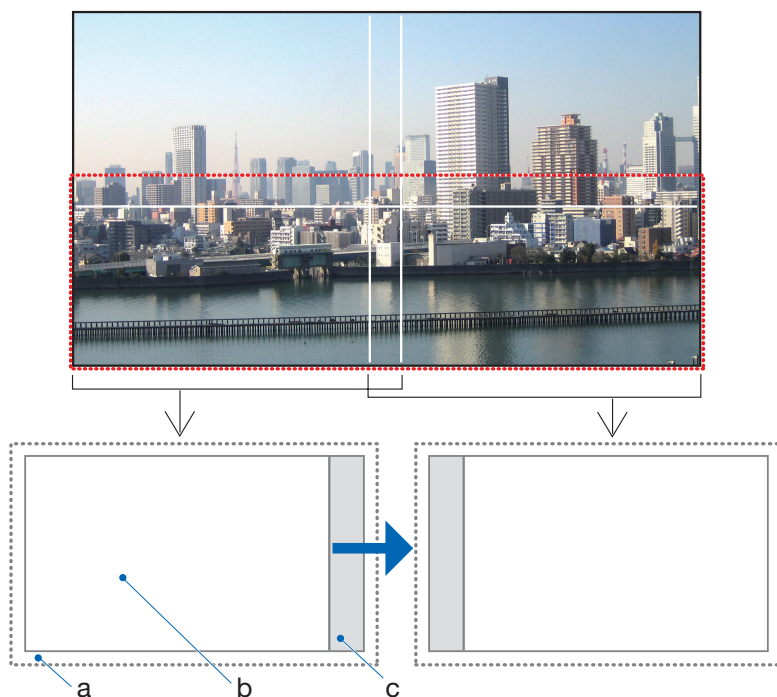

* The 2 screens are separated in the diagram for explanatory purposes.

a: Inactive area (area not displaying images) / b: Black level adjustment area / c: Edge blending area

Adjust the [BOTTOM-RIGHT-H] on the right side of the bottom-left screen and align the right edge of the black level adjustment area with the left edge of the inactive area of the bottom-right screen.

- ③ Press the ▼/▲ button to select [APPLY] and press the ENTER or ► button.
The changes to the black level adjustment area will be applied.
- ④ Press the ▼/▲ button and select either [RED], [GREEN], or [BLUE], then press the ◀/▶ button to adjust the black level.
Adjust the settings so that the edge blending area and the black level are uniform.
When [ALL] is selected, [RED], [GREEN], and [BLUE] are adjusted simultaneously.

6. Use the same process to adjust other projectors.

TIP:

- When displaying a signal with a different resolution, perform the Edge Blending function from the start.
 - Setting of [MARKER] will not be saved and return to [OFF] when the projector is turned off.
 - The [BLACK LEVEL] can be adjusted to make it brighter only.
-

4. Using On-Screen Menu

4-1. Basic operations of the on-screen menu

Display the on-screen menu to adjust the quality of the image projected by the projector and to switch the operation mode of the projector. Hereinafter, "on-screen menu" will be abbreviated to "menu".

NOTE:

- The menu screen in this manual may differ slightly from the actual one.

Configuration of the on-screen menu screen

To display the menu, press the MENU button on the projector or remote control. Press the EXIT button to close the menu.

This section describes how to view and operate the menu.

Preparation: Turn on the projector and project the image on the screen.

1. Press the MENU button.

- Press the EXIT button to cancel the menu.
- The display position of the menu on the screen can be changed. ("MENU POSITION" → page 73)

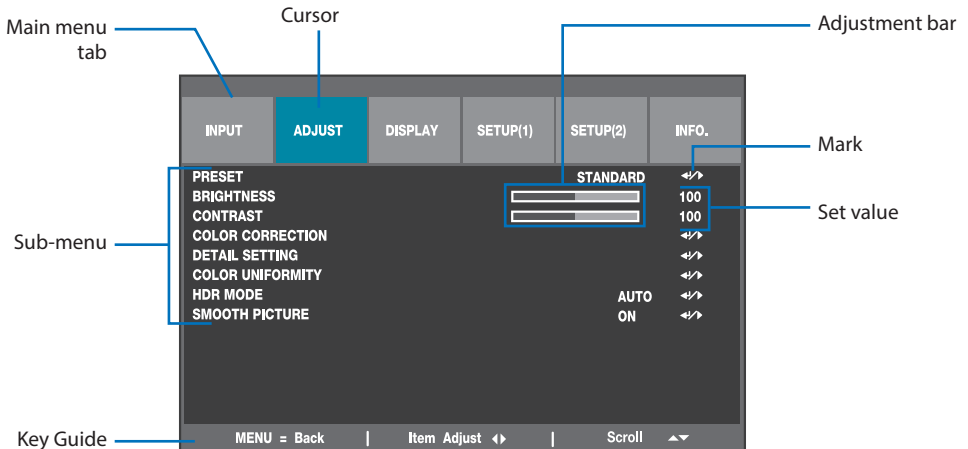

2. Press the ◀/▶ button.

The cursor will move to the main menu tab (INPUT ↔ ADJUST ↔ DISPLAY ↔ SETUP(1) ↔ SETUP(2) ↔ INFO.).

When the main menu tab changes, the sub-menu also changes.



3. With the cursor on the main menu tab, press the ▼/▲ button.

The cursor will move to the sub-menu.

- To return to the main menu tab from the sub-menu, press the MENU button.
- Press the EXIT button to cancel the menu.

4. Press the ▼/▲ button to move the cursor to the sub-menu that you want.

The mark displayed at the right end of the sub-menu indicates a key operation.

	Press the ◀/▶ button to select the setting value.
	Press the ENTER button or ▶ button to continue selecting.

5. Move the cursor to the sub-menu that you want, then press the ◀/▶ button or ENTER button.

- An additional sub-menu that is one layer deep may also be displayed.

In this case, move the cursor to the sub-menu with the ▼/▲ button, then press the ENTER button.

Adjustment bar

To change the value on the adjustment bar, press the ◀/▶ button.

When you press the ◀/▶ button, the menu screen disappears and an adjustment bar is displayed at the bottom of the screen.



Press the ◀/▶ button to adjust and MENU button to confirm.

Confirmation message

A confirmation message is displayed when you reset the adjustment value etc.

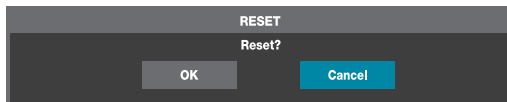

Press the ◀/▶ button to move the cursor to [OK] or [CANCEL], then press the ENTER button.

Changing the number

This section explains how to change the factory default IP address and subnet mask etc. in the network settings of the menu.

1. Press the MENU button and select [SETUP(1)] → [NETWORK SETTINGS] → [WIRED LAN].

The [WIRED LAN] screen is displayed.

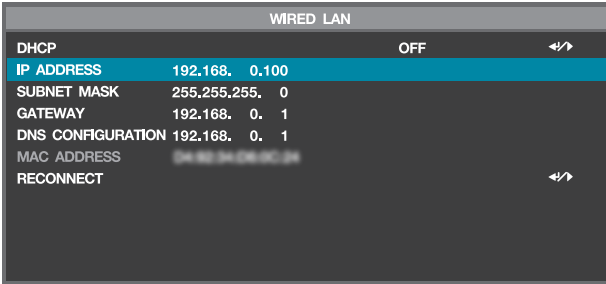

2. Press the ▼/▲ button to move the cursor to the [IP ADDRESS], then press the ENTER button.
3. Press the ◀/▶ button to move the cursor to the value to change.
4. Press the ▼/▲ button to change the value, then press the ENTER button.
 - Press the ▲ button to increase the value. Press the ▼ button to decrease the value.

4-2. List of Menu Items

Some menu items are not available depending on the input source.

Menu Item		Default	Options		
INPUT	INPUT SELECTION	HDMI1	HDMI1, HDMI2, DisplayPort1, DisplayPort2, HDBaset, SDI		
	AUTO ADJUST				
	HDMI EQUALIZER	AUTO	AUTO,1,2,3,4,5,6,7		
	COLOR SPACE	AUTO	AUTO, YPbPr, YCbCr, RGB PC, RGB VIDEO		
	NOISE REDUCTION	OFF	OFF, ON		
	AUTO SOURCE	OFF	OFF, ON		
	TEST PATTERN		CROSS HATCH, COLOR BAR, CHECKER BOARD, V BURST, WHITE, RED, GREEN, BLUE, BLACK		
ADJUST	PRESET	STANDARD	STANDARD, VIDEO, sRGB		
	BRIGHTNESS	100	0 - 200		
	CONTRAST	100	0 - 200		
	COLOR CORRECTION	R	HUE/SATURATION/GAIN	0 - 1000	
		G	HUE/SATURATION/GAIN		
		B	HUE/SATURATION/GAIN		
		C	HUE/SATURATION/GAIN		
		M	HUE/SATURATION/GAIN		
		Y	HUE/SATURATION/GAIN		
		W	RED GAIN/GREEN GAIN/BLUE GAIN		
	RESET				
	DETAIL SETTING	SATURATION	100	0 - 200	
		HUE	100	0 - 200	
		SHARPNESS	10	0 - 20	
		GAMMA	2.2	1.0, 1.8, 2.0, 2.2, 2.35, 2.5, DICOM SIM.	
		COLOR GAMUT	NATIVE	NATIVE, REC709, EBU, SMPTE	
		COLOR TEMPERATURE	NATIVE	3200K, 5400K, 6500K, 7500K, 9300K, NATIVE	
		INPUT BALANCE	RED GAIN	100	0 - 200
			GREEN GAIN		
			BLUE GAIN		
			RED OFFSET		
			GREEN OFFSET		
	BLUE OFFSET				
RESET					
COLOR UNIFORMITY	MODE	OFF	OFF, ON		
	LOCATION X	0	0 - 8		
	LOCATION Y	0	0 - 5		
	RED GAIN/GREEN GAIN/BLUE GAIN	0	-150 - 150		
	RESET				
HDR MODE	AUTO	OFF, AUTO, PQ-400, PQ-500, PQ-1000, HLG			
SMOOTH PICTURE	ON	OFF, ON			
DISPLAY	ASPECT RATIO	NORMAL	5:4, 4:3, 16:10, 16:9, 1.88, 2.35, LETTERBOX, NORMAL, NATIVE		
	ORIENTATION	DESKTOP FRONT	DESKTOP FRONT, CEILING FRONT, DESKTOP REAR, CEILING REAR		
	ZOOM	DIGITAL ZOOM	0%		
		HORIZONTAL POSITION	0		
		VERTICAL POSITION	0		
		RESET	0		
	OVERSCAN	OFF	OFF, CROP, ZOOM		
	BLANKING	TOP/BOTTOM	0	0 - 360	
		LEFT/RIGHT	0	0 - 534	
		RESET			

4. Using On-Screen Menu

Menu Item		Default	Options		
DISPLAY	GEOMETRIC CORRECTION	MODE	OFF	OFF, KEYSTONE, CORNERSTONE, PICUSHION/BARREL, PC TOOL	
		KEYSTONE	H KEYSTONE	0	-360 - 360
			V KEYSTONE	0	-360 - 360
			ROTATION	0	-250 - 250
			THROW RATIO		
			RESET		
		CORNERSTONE	TOP-LEFT-H	0	-192 - 192
			TOP-LEFT-V	0	-120 - 120
			TOP-RIGHT-H	0	-192 - 192
			TOP-RIGHT-V	0	-120 - 120
			BOTTOM-LEFT-H	0	-192 - 192
			BOTTOM-LEFT-V	0	-120 - 120
			BOTTOM-RIGHT-H	0	-192 - 192
			BOTTOM-RIGHT-V	0	-120 - 120
			H LINEARITY	0	-350 - 350
			V LINEARITY	0	-200 - 200
		RESET			
		PICUSHION / BARREL	TOP	0	-250 - 300
			BOTTOM	0	-250 - 300
			LEFT	0	-250 - 300
	RIGHT		0	-250 - 300	
	H KEYSTONE		0	-60 - 60	
	V KEYSTONE		0	-40 - 40	
	THROW RATIO				
	RESET				
	PC TOOL	OFF	OFF, 1, 2		
	EDGE BLENDING	MODE	OFF	OFF, ON	
		MARKER	OFF	OFF, ON	
		RANGE	TOP-BOTTOM	0	0 - 360
			LEFT-RIGHT	0	0 - 534
		WHITE LEVEL	TOP-BOTTOM	0	0, 100 - 1000
			LEFT-RIGHT	0	0, 100 - 1600
		BLACK LEVEL	TOP-LEFT-H	0	0 - 1920
TOP-LEFT-V			0	0 - 1080	
TOP-RIGHT-H			0	0 - 1920	
TOP-RIGHT-V			0	0 - 1080	
BOTTOM-LEFT-H			0	0 - 1920	
BOTTOM-LEFT-V			0	0 - 1080	
BOTTOM-RIGHT-H			0	0 - 1920	
BOTTOM-RIGHT-V	0		0 - 1080		
APPLY					
ALL					
RED/GREEN/BLUE	0	0 - 255			
RESET					
SCREEN	SCREEN TYPE	16:10	16:10, 16:9, 4:3, 2.35:1		
	POSITION	0	-120 - 0 - 120 (When 16:9), -320 - 0 - 320 (When 4:3), -263 - 0 - 263 (When 2.35:1)		

4. Using On-Screen Menu

Menu Item			Default	Options		
DISPLAY	LENS	LENS LOCK		OFF	OFF, ON	
		LENS TYPE		1.40-2.11:1	0.31-0.33:1, 0.55-0.75:1, 0.74-1.08:1, 1.05-1.41:1, 1.40-2.11:1, 2.10-4.00:1	
		LENS CONTROL	ZOOM			
			FOCUS			
			SHIFT			
		LENS MEMORY		MEMORY 1 - MEMORY 10	STORE, MOVE, RESET	
LENS CALIBRATION						
SETUP(1)	REF. LIGHT MODE	REF. LIGHT MODE		FULL	ECO, FULL, NORMAL	
		REF. LIGHT ADJUST		100*1	30 - 100*2	
		CONSTANT BRIGHTNESS		OFF	OFF, ON	
		DYNAMIC CONTRAST		OFF	OFF, ON	
		LIGHT OFF TIMER		OFF	OFF, 0.5 SEC, 1.0 SEC, 1.5 SEC, 2.0 SEC, 3.0 SEC, 4.0 SEC	
	FAN MODE		AUTO	AUTO, HIGH		
	REMOTE CONTROL	REMOTE SENSOR		ON	OFF, ON	
		CONTROL ID NUMBER		0	0 - 99	
		RESET				
	FREEZE					
	TRIGGER		OFF	OFF, SCREEN, 5:4, 4:3, 16:10, 16:9, 1.88, 2.35, LETTERBOX, NORMAL, NATIVE, RS232		
	STANDBY TIMER		OFF	OFF, ON		
	OFF TIMER		30 MIN	30 MIN, 60 MIN, 90 MIN		
	NETWORK SETTINGS	WIRED LAN	DHCP			
			IP ADDRESS			
			SUBNET MASK			
			GATEWAY			
			DNS CONFIGURATION			
			MAC ADDRESS			
			RECONNECT			
			AMX BEACON		OFF	OFF, ON
	SETUP(2)	POWER OPTIONS	STANDBY MODE		POWER-SAVING	POWER-SAVING, LAN, HDBaseT
			AUTO POWER OFF		OFF	OFF, 5 MIN, 10 MIN, 15 MIN, 20 MIN
DIRECT POWER ON			OFF	OFF, ON		
BACKGROUND		BLUE	BLUE, BLACK, LOGO			
MENU		STARTUP LOGO		BLACK	BLUE, BLACK	
		MENU POSITION		CENTER	TOP-LEFT, TOP-RIGHT, BOTTOM-LEFT, BOTTOM-RIGHT, CENTER	
		MENU TRANSLUCENT		0	0, 25, 50, 75	
		DISPLAY TIME		AUTO 30 SEC	MANUAL, AUTO 10 SEC, AUTO 30 SEC, AUTO 60 SEC	
		MESSAGE DISPLAY		ON	OFF, ON	
		MENU ANGLE		0	0°, 90°, 270°	
IMAGE MEMORY		LOAD			1, 2, 3, 4, RESET	
		STORE			1, 2, 3, 4	
LANGUAGE			ENGLISH, FRANÇAIS, ESPAÑOL, DEUTSCH, PORTUGUÊS, 简体中文, 繁體中文, 日本語, 한국어			
RESET						

*1: [85] when using X171Q-B/X171Q-W with 100-130 VAC.

*2: [30 - 85] when using X171Q-B/X171Q-W with 100-130 VAC.

4. Using On-Screen Menu

Menu Item		Default	Options	
INFO.	MODEL NO.			
	SERIAL NUMBER			
	VERSION	CONTROL MODULE		
		VIDEO MODULE		
		OPTION MODULE		
		FORMATTER MODULE		
		LIGHT MODULE		
	LIGHT HOURS USED			
	SOURCE	INPUT TERMINAL		
		SIGNAL FORMAT		
		SCANNING FREQUENCY		
		PIXEL CLOCK		
		SIGNAL TYPE		
		HDR MODE		
	SYSTEM STATUS	AC VOLTAGE		
		FAN MODE		
		LASER POWER		
		CONSTANT BRIGHTNESS		
	THERMAL STATUS	TEMPERATURE		
		FAN SPEED		

4-3. INPUT

INPUT SELECTION

Select the input terminal to project.

HDMI 1	Projects the image of the device connected to the HDMI 1 input terminal.
HDMI 2	Projects the image of the device connected to the HDMI 2 input terminal.
DisplayPort 1	Projects the image of the device connected to the DisplayPort 1 input terminal.
DisplayPort 2	Projects the image of the device connected to the DisplayPort 2 input terminal.
HDBaseT	Projects the image of the device connected to the HDBaseT port.
SDI	Projects the image of the device connected to the SDI input terminal.

AUTO ADJUST

When executed, the projected image is automatically adjusted.

- Automatic adjustment can also be performed by pressing the AUTO ADJUST button on the projector.

HDMI EQUALIZER

Depending on the length and quality of the HDMI cable, the HDMI signal may experience loss or noise and the image will not display correctly.

The HDMI EQUALIZER function will correct HDMI image signal loss.

AUTO	Automatically correct signal loss.
1 - 7	Select the amount of correction in accordance with the degree of signal loss. Higher numbers correspond to greater correction.

NOTE:

- Not all signal loss can be corrected.

COLOR SPACE

Set the color space according to the video input signal.

AUTO	Switches to the corresponding color space automatically according to the video input signal.
YPbPr	Switches the color space to ITU-R BT 601.
YCbCr	Switches the color space to ITU-R BT 709.
RGB-PC	Use the RGB color space and set it to black (0, 0, 0) and white (255, 255, 255). (When using 8-bit color)
RGB-VIDEO	Set black (16, 16, 16) and white (235, 235, 235) using the RGB color space to be compatible with the luminance values defined in the digital component standard. (When using 8-bit color)

NOISE REDUCTION

When projecting a video image, the noise reduction function can be used to reduce screen noise (roughness and disturbance). You can choose the noise reduction effect from 4 levels [0] [1] [2] [3] according to the noise level.

AUTO SOURCE

Checks the video input signal automatically and projects the image of the first detected signal.

TEST PATTERN

Project a test pattern.

- Press the ◀/▶ button to change the pattern of the test pattern.
- Press the EXIT button to erase the test pattern.
- You can also display the test pattern by pressing the TEST button on the remote control.

4-4. ADJUST

PRESET

Select the optimal settings for the projected picture.

STANDARD	Use this setting when making a presentation with PowerPoint etc.
VIDEO	Use this setting when projecting TV programs or general video sources.
sRGB	Use this setting to recreate colors according to the sRGB standard.

BRIGHTNESS

Makes the image brighter or darker.

CONTRAST

Makes the difference between the dark and bright areas of the image clearer or lighter.

COLOR CORRECTION

Adjust the tone of the red, green, blue, yellow, magenta (purple) and cyan (bright bluish green) colors.

R (red)	HUE	Adjusts the color near the area centered around red. Move in the "+" direction to make the color appear more yellow and move in the "-" direction to make the color appear more magenta.
	SATURATION	Adjusts the intensity of the red color. Move in the "+" direction to make the color more vivid and move in the "-" direction to make the color less vivid (white).
	GAIN	Adjusts the brightness of the red color. Move in the "+" direction to make the color look brighter and move in the "-" direction to make it look darker (black).
G (green)	HUE	Adjusts the color near the area centered around green. Move in the "+" direction to make the color appear more cyan and move in the "-" direction to make the color appear more yellow.
	SATURATION	Adjusts the intensity of the green color. Move in the "+" direction to make the color more vivid and move in the "-" direction to make the color less vivid (white).
	GAIN	Adjusts the brightness of the green color. Move in the "+" direction to make the color look brighter and move in the "-" direction to make it look darker (black).
B (blue)	HUE	Adjusts the color near the area centered around blue. Move in the "+" direction to make the color appear more magenta and move in the "-" direction to make the color appear more cyan.
	SATURATION	Adjusts the intensity of the blue color. Move in the "+" direction to make the color more vivid and move in the "-" direction to make the color less vivid (white).
	GAIN	Adjusts the brightness of the blue color. Move in the "+" direction to make the color look brighter and move in the "-" direction to make it look darker (black).

C (cyan)	HUE	Adjusts the color near the area centered around cyan. Move in the "+" direction to make the color appear more blue and move in the "-" direction to make the color more green.
	SATURATION	Adjusts the intensity of the cyan color. Move in the "+" direction to make the color more vivid and move in the "-" direction to make the color less vivid (white).
	GAIN	Adjusts the brightness of cyan. Move in the "+" direction to make the color look brighter and move in the "-" direction to make it look darker (black).
M (magenta)	HUE	Adjusts the color near the area centered around magenta. Move in the "+" direction to make the color appear more red and move in the "-" direction to make the color more blue.
	SATURATION	Adjusts the intensity of the magenta color. Move in the "+" direction to make the color more vivid and move in the "-" direction to make the color less vivid (white).
	GAIN	Adjusts the brightness of magenta. Move in the "+" direction to make the color look brighter and move in the "-" direction to make it look darker (black).
Y (yellow)	HUE	Adjusts the color near the area centered around yellow. Move in the "+" direction to shift the color closer to green and move in the "-" direction to shift the color closer to red.
	SATURATION	Adjusts the intensity of the yellow color. Move in the "+" direction to make the color more vivid and move in the "-" direction to make the color less vivid (white).
	GAIN	Adjusts the brightness of yellow. Move in the "+" direction to make the color look brighter and move in the "-" direction to make it look darker (black).
W (white)	RED GAIN	Adjusts the white color. Move in the "+" direction to shift the color closer to red and move in the "-" direction to shift the color closer to cyan.
	GREEN GAIN	Adjusts the white color. Move in the "+" direction to shift the color closer to green and move in the "-" direction to shift the color closer to magenta.
	BLUE GAIN	Adjusts the white color. Move in the "+" direction to shift the color closer to blue and move in the "-" direction to shift the color closer to yellow.
RESET	Returns all adjustment values for color correction to the factory settings.	

DETAIL SETTING

• SATURATION

Makes the color darker or lighter.

• HUE

Makes the image appear reddish or greenish.

• SHARPNESS

Makes the picture sharp and soft.

• GAMMA

Select the gradation of the picture. With this, even dark areas can be reproduced vividly.

NOTE:

- The [DICOM SIM.] setting on the projector is used to adjust the image to an image that approximates the DICOM standard and thus the image may not be projected correctly. For this reason, use the [DICOM SIM.] setting only for educational purposes and not for actual diagnosis.
 - The DICOM in [DICOM SIM.] is the name of the global standard used for storing and communicating medical images. It is used in computer tomography (CT), magnetic resonance imaging (MRI), endoscopes and other medical diagnosis.
-

• COLOR GAMUT

You can change the projector's color gamut according to the projected image.

• COLOR TEMPERATURE

Adjust the balance of the colors (R, G, B) to optimize the color reproducibility.

A color temperature with a high numerical value becomes bluish white while one with a low numerical value becomes reddish white. The setting can be selected from 3200K, 5400K, 6500K, 7500K, 9300K and NATIVE.

• INPUT BALANCE

Adjust the white level and black level of the signal to achieve the best color reproduction.

RED GAIN	Adjusts the white color of the picture.
GREEN GAIN	
BLUE GAIN	
RED OFFSET	Adjusts the black color of the picture.
GREEN OFFSET	
BLUE OFFSET	
RESET	Returns all adjustment values for INPUT BALANCE to the factory settings.

NOTE:

- When the white balance is adjusted, the color temperature value differs from the actual color tone.

COLOR UNIFORMITY

This adjusts for unevenness of colors.

MODE	This sets whether or not the uniformity function is activated.
LOCATION X	This specifies the position in the horizontal direction.
LOCATION Y	This specifies the position in the vertical direction.
RED GAIN GREEN GAIN BLUE GAIN	This adjusts the brightness of the color components.
RESET	Returns all adjustment values for COLOR UNIFORMITY to the factory settings.

HDR MODE

This selects the format of the HDR video signal input from an HDR-compatible device.

OFF	No HDR video signal processing is performed.
AUTO	The signal is identified automatically.
PQ-400	Select this when inputting video signals in PQ-400 format.
PQ-500	Select this when inputting video signals in PQ-500 format.
PQ-1000	Select this when inputting video signals in PQ-1000 format.
HLG	Select this when inputting video signals in HLG format.

SMOOTH PICTURE

This sets the display resolution.

OFF	The picture is set to a WUXGA resolution (1920 × 1200).
ON	The picture is set to a 4K resolution (3840 × 2400).

4-5. DISPLAY

ASPECT RATIO

Select the aspect ratio of the screen.

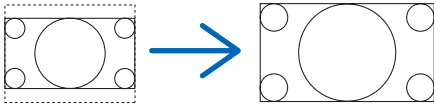
5:4	Projects the picture in 5:4 aspect ratio
4:3	Projects the picture in 4:3 aspect ratio.
16:10	Projects the picture in 16:10 aspect ratio
16:9	Projects the picture in 16:9 aspect ratio
1.88	Projects the picture in 1.88:1 (vista) aspect ratio
2.35	Projects the picture in 2.35:1 (cinemascope) aspect ratio
LETTERBOX	<p>Projects a 16:9 letterbox signal.</p> <p style="text-align: center;">LETTERBOX</p> 
NORMAL	Automatically determines the aspect ratio of the input signal for projection. Depending on the input signal, the aspect ratio may be misidentified. If the wrong aspect ratio is identified, select an appropriate aspect ratio from the following items.
NATIVE	<p>When [SMOOTH PICTURE] is [ON]</p> <p>Projects directly with the resolution of the computer input signal when the resolution of the computer input signal is smaller than the resolution of the projector (3840 × 2400). If the resolution is higher than the projector's resolution, the center of the screen is projected at the resolution of the computer input signal.</p> <p>When [SMOOTH PICTURE] is [OFF]</p> <p>Projects directly with the resolution of the computer input signal when the resolution of the computer input signal is smaller than the resolution of the projector (1920 × 1200). If the resolution is higher than the projector's resolution, the center of the screen is projected at the resolution of the computer input signal.</p>

ORIENTATION

Select the orientation according to the installation status of the projector and screen.

WARNING

Should special works be required, for example to suspend the projector from the ceiling, consult your dealer.

Never try to install the projector yourself in such cases. The projector could drop and cause injury.

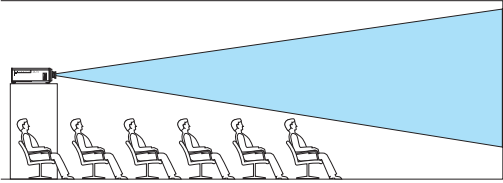
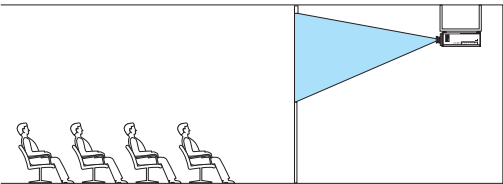
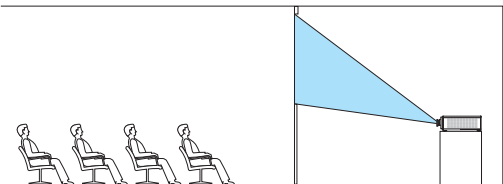
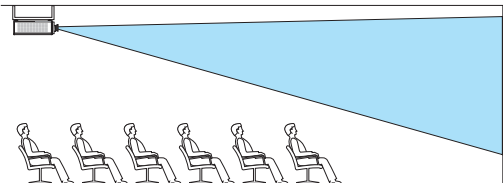
<p>DESKTOP FRONT</p>	<p>Install on a table and project from the front of the screen</p> 
<p>CEILING REAR</p>	<p>Install on the ceiling and project from the back of the screen</p> 
<p>DESKTOP REAR</p>	<p>Install on a table and project from the back of the screen</p> 
<p>CEILING FRONT</p>	<p>Install on the ceiling and project from the front of the screen</p> 

NOTE:

- [ORIENTATION] will not be changed even if [RESET] is performed.

ZOOM

Enlarge the screen up to a maximum of 4 times.

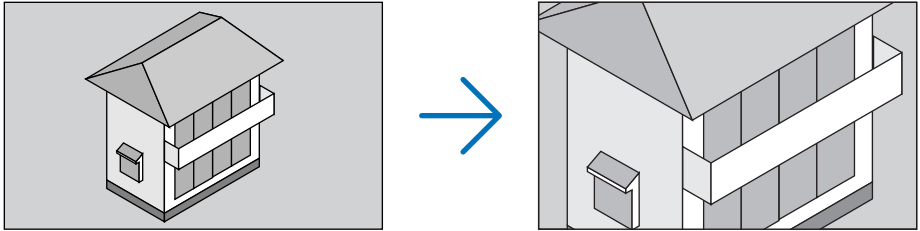

DIGITAL ZOOM	Enlarges the screen by up to 4 times.
HORIZONTAL POSITION	When the screen is enlarged with digital zoom, press the ◀▶ button to move the screen in the horizontal direction.
VERTICAL POSITION	When the screen is enlarged with digital zoom, press the ◀▶ button to move the screen in the vertical direction.
RESET	Returns the screen to its original state.

OVERSCAN

Set overscan (process to cut the frame around the screen).

OFF	Overscan will not be performed.
CROP	Projects the image with the surroundings hidden.
ZOOM	Enlarges the image to fit the projection screen.

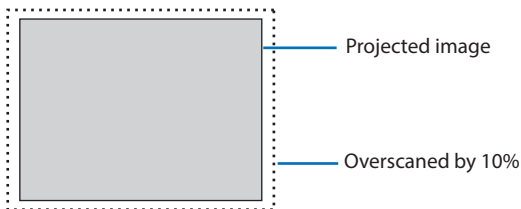

BLANKING

Adjusts the display range (BLANKING) of the top, bottom, left, and right edges of the video signal.

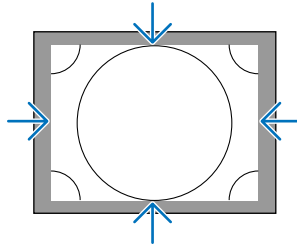

GEOMETRIC CORRECTION

Corrects the distortion of the projection screen when projecting from an oblique direction to the screen to fit the image to the screen frame.

• MODE

Set pattern for correcting distortion. If [OFF] is selected, the [GEOMETRIC CORRECTION] becomes ineffective.

• KEYSTONE

Adjusts the keystone distortion by combining the horizontal adjustment and vertical adjustment of the projection screen.

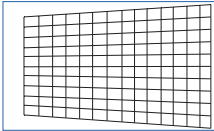
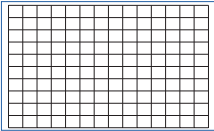
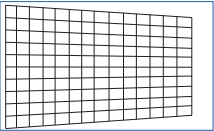
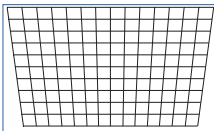
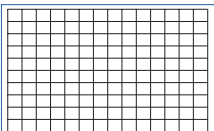
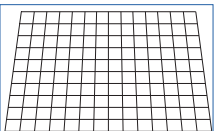
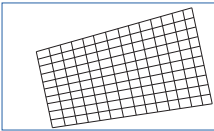
H KEYSTONE	<div style="display: flex; justify-content: space-around; align-items: center;"> <div style="text-align: center;"> <p>-360 (-36°)</p>  </div> <div style="text-align: center;"> <p>0</p>  </div> <div style="text-align: center;"> <p>360 (36°)</p>  </div> </div>
V KEYSTONE	<div style="display: flex; justify-content: space-around; align-items: center;"> <div style="text-align: center;"> <p>-360 (-36°)</p>  </div> <div style="text-align: center;"> <p>0</p>  </div> <div style="text-align: center;"> <p>360 (36°)</p>  </div> </div>
ROTATION	<p>Allows the image to be rotated after adjusting the horizontal and vertical keystone distortion.</p> <div style="text-align: center;">  </div>
THROW RATIO	Adjusts according to the projection ratio of the optional lens used.
RESET	Returns the keystone adjustment value to the factory setting.

• CORNERSTONE

TOP-LEFT

Adjusts the top left corner distortion.

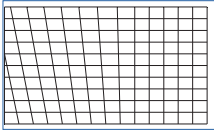
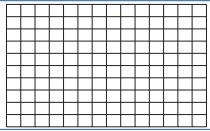
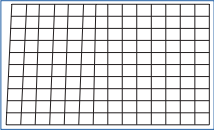
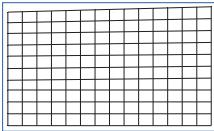
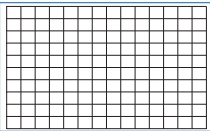
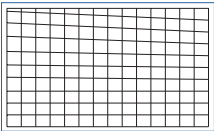
HORIZONTAL	<p>-192 (Pixels)</p> 	<p>0</p> 	<p>192 (Pixels)</p> 
VERTICAL	<p>-120 (Pixels)</p> 	<p>0</p> 	<p>120 (Pixels)</p> 

TOP-RIGHT

Adjusts the top right corner distortion.

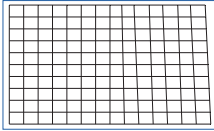
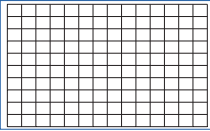
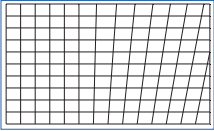
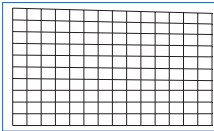
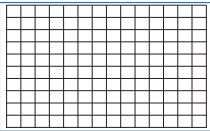
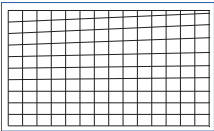
HORIZONTAL	<p>-192 (Pixels)</p> 	<p>0</p> 	<p>192 (Pixels)</p> 
VERTICAL	<p>-120 (Pixels)</p> 	<p>0</p> 	<p>120 (Pixels)</p> 

BOTTOM-LEFT

Adjusts the bottom left corner distortion.

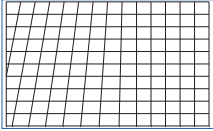
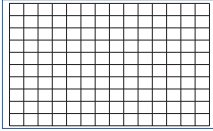
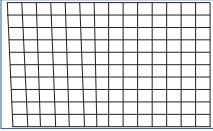
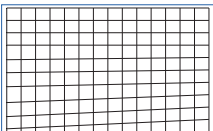
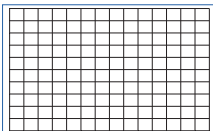
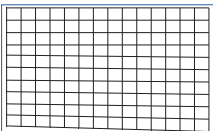
HORIZONTAL	<p>-192 (Pixels)</p> 	<p>0</p> 	<p>192 (Pixels)</p> 
VERTICAL	<p>-120 (Pixels)</p> 	<p>0</p> 	<p>120 (Pixels)</p> 

BOTTOM-RIGHT

Adjusts the bottom right corner distortion.

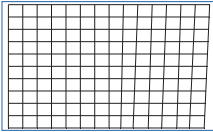
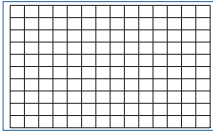
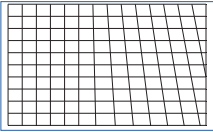
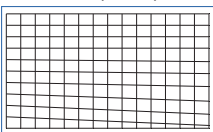
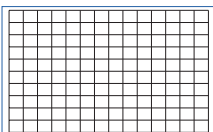
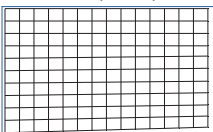
HORIZONTAL	<p>-192 (Pixels)</p> 	<p>0</p> 	<p>192 (Pixels)</p> 
VERTICAL	<p>-120 (Pixels)</p> 	<p>0</p> 	<p>120 (Pixels)</p> 

H LINEARITY

This corrects the horizontal linearity.

V LINEARITY

This corrects the vertical linearity.

RESET

Returns all adjustment values for CORNERSTONE to the factory settings.

• **PINCUSHION / BARREL**

Adjust this when projecting onto a cylindrical screen or spherical surface.

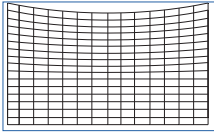
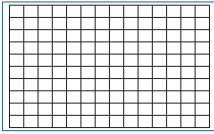
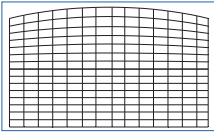
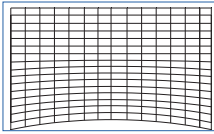
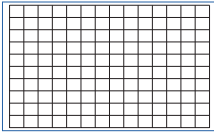
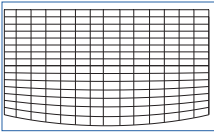
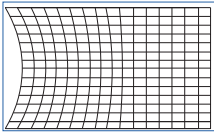
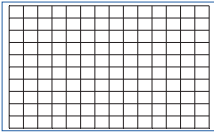
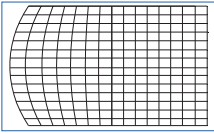
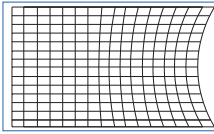
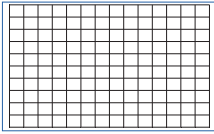
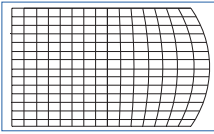
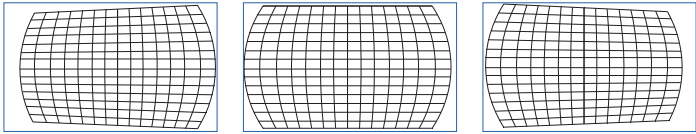
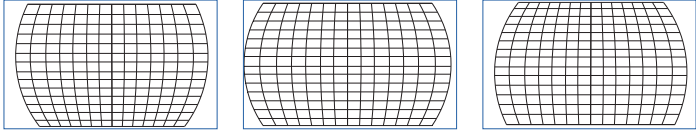
TOP	-250 (-50%) 	0 	300 (60%) 
BOTTOM	-250 (-50%) 	0 	300 (60%) 
LEFT	-250 (-50%) 	0 	300 (60°) 
RIGHT	-250 (-50%) 	0 	300 (60°) 
H KEYSTONE	Example of keystone adjustment in the horizontal direction: 		
V KEYSTONE	Example keystone adjustment in the vertical direction: 		
THROW RATIO	Adjusts according to the projection ratio of the optional lens used.		
RESET	Returns the adjustment value of [PINCUSHION / BARREL] to the factory setting.		

• PC TOOL

Recall the geometric correction data that is registered in the projector beforehand.

Two types of correction data can be registered.

In addition, recall the geometric correction data that is registered in the projector after adjusting with the ProAssist software application.

NOTE:

- As electrical correction is carried out in geometric correction, the brightness may be affected and the picture quality may be degraded.

EDGE BLENDING

Adjust the edges (boundaries) of the projection screen when projecting high-resolution images by combining multiple projectors on the left, right, top and bottom. (→ page 41)

MODE	Enables/disables the edge blending function.
MARKER	Set whether to display the markers when adjusting the width of edge blending area.
RANGE	This adjusts the edge rendering start position.
WHITE LEVEL	Adjust the width of edge blending area.
BLACK LEVEL	Adjusts the black level of non-overlapping images on the multiple screens.
RESET	Returns the edge blending adjustment value to the factory setting.

Example of a screen that is projected by arranging the images of 4 projectors with 2 units each vertically and horizontally.

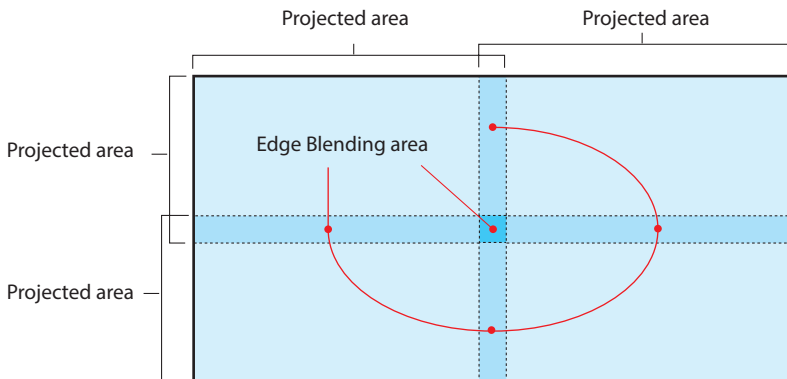

SCREEN

SCREEN TYPE	Set the ratio of the screen to project. Select from 16:10, 16:9, 4:3 or 2.35:1.
POSITION	This adjusts the position of the projected image when "SCREEN TYPE" is set to anything other than [16:10].

LENS

• LENS LOCK

Disables the use of the ZOOM/FOCUS adjustment, lens shift and [LENS CALIBRATION] functions. By performing [LENS LOCK], it is possible to prevent other people from adjusting the lens without permission after the lens has been adjusted.

• LENS TYPE

This selects the type of lens mounted on the projector.

• LENS CONTROL

Adjusts the ZOOM/FOCUS and shifts the lens.

- [LENS CONTROL] can also be performed by pressing the button on the projector or remote control.

Follow the procedure below to operate.

1. Move the cursor to [LENS CONTROL] in the menu, then press the ENTER or ► button.

The ZOOM/FOCUS adjustment screen will be displayed.

2. To adjust the focus, press the ◀/▶ button.

3. To adjust the zoom, press the ▼/▲ button.

4. When you have finished adjusting the focus and zoom, press the ENTER button.

The lens shift adjustment screen will be displayed.

5. Press the ▼▲◀▶ button.

The lens shifts in the direction of the pressed button.

6. When the lens shift is complete, press the ENTER button.

The ZOOM/FOCUS adjustment screen will be displayed.

Repeat Step 2 to 6 above.

7. To exit [LENS CONTROL], press the MENU button.

• LENS MEMORY

This function serves to store the adjusted values when using the [LENS SHIFT], [ZOOM], and [FOCUS] functions of the projector. A maximum of 10 values can be stored. The adjusted values stored in memory can be used as a reference to the current.

NOTE:

- [LENS MEMORY] will not be changed even if [RESET] is performed.

• LENS CALIBRATION

The lens unit and lens shift adjustment range are calibrated and the lens is shifted back to the home position.

After replacing the lens unit, be sure to execute [LENS CALIBRATION]. (→ page 21)

4-6 SETUP(1)

REF. LIGHT MODE

Three [REF. LIGHT MODE] options can be selected according to the purpose of use. You can also adjust output power and change luminance (brightness).

This can also be used to adjust the brightness between the different projectors when using a combination of multiple projectors.

REF. LIGHT MODE	ECO	Brightness will be at about 90%* ¹ . The cooling fan will also slow down accordingly. Lower power consumption.
	FULL	Brightness changes to 100%* ¹ and the screen becomes bright.
	NORMAL	This is the standard mode.
REF. LIGHT ADJUST		When the mode is set to [NORMAL] in [REF. LIGHT MODE], the brightness can be adjusted within a range of 30% to 100%* ² (in 1% increments).
CONSTANT BRIGHTNESS	OFF	[CONSTANT BRIGHTNESS] mode will be canceled.
	ON	Maintains the brightness that is in effect at the time [ON] is selected. Unless [OFF] is selected, the same settings will remain in effect even when the projector is turned off. <ul style="list-style-type: none"> To re-adjust the brightness, first turn this setting [OFF] before making further adjustments.
DYNAMIC CONTRAST		If [ON] is selected, the most optimal contrast ratio is used according to the picture.
LIGHT OFF TIMER		When [DYNAMIC CONTRAST] is set to [ON], the laser emission stops when the time set in [LIGHT OFF TIMER] elapses upon the entire projected screen turning black. If [LIGHT OFF TIMER] is set to [OFF], laser emission will not stop even when the screen turns black.

The brightness will change when using X171Q-B/X171Q-W with 100-130 VAC.

*1: about 85%

*2: 30 to 85%

NOTE:

- If [CONSTANT BRIGHTNESS] is set to [ON], then [REF. LIGHT MODE] and [REF. LIGHT ADJUST] cannot be selected.

TIP:

- Brightness normally decreases with use, but by selecting [CONSTANT BRIGHTNESS] mode, sensors inside the projector detect brightness and automatically adjust the output, thereby maintaining a constant brightness throughout the life of the light module. However, if output is already at its maximum, brightness will decrease with use.

FAN MODE

Set the cooling fan operation to lower the temperature inside the projector.

AUTO	Turns the fan at an appropriate speed using the temperature sensor inside the projector. The fan rotation is quiet.
HIGH	The brightness decreases and the fan turns constantly at high speed.

NOTE:

- Be sure to set it to [HIGH] when using the projector for several consecutive days.
- [FAN MODE] will not be changed even if [RESET] is performed.
- If you are using the projector at an altitude of about 1499 m/ 5000 ft or more above sea level, be sure to set the [FAN MODE] to [HIGH]. If you do not set it to [HIGH], the interior of the projector will get hot, resulting in a malfunction.
- If the projector is used at an altitude of about 1499 m/ 5000 ft or more above sea level without setting [FAN MODE] to [HIGH], the temperature protector may be activated and the power may be turned off automatically.
Furthermore, since the internal temperature rises after the light source turns off, the temperature protector may be activated and the power may not turn on. In this case, wait for a while before turning on the power.
- When used at a high altitude, replacement of optical components (such as the light source etc.) may be accelerated.

REMOTE CONTROL

Configure the remote sensor setting and control ID.

- When [CONTROL ID] is used, IDs can be assigned to multiple projectors, and each projector can be operated individually by switching the ID using a single remote control. It is also used when setting the same ID to multiple projectors and performing batch operations with a single remote control.

REMOTE SENSOR	Select whether to activate or disable the remote control sensor.
CONTROL ID NUMBER	Select a number from 1 to 99 to assign to the projector. When "0" is selected, the [CONTROL ID] function is disabled.
RESET	Delete the control ID set in the projector.

How to set/change the ID in the remote control

1. Turn on the power of the projector.
2. Press the numeric buttons while holding down the ID SET button on the remote control to set the remote control ID.

For example, to change the number to [3], press the number 3.
To cancel the control ID setting, press the number 0 while holding down the ID SET button.

TIP:

- Remote control IDs can be registered from 1 to 99.

NOTE:

- If the battery of the remote control is exhausted or removed, the ID may be cleared after a while.
- If any button is pressed with the remote control battery removed, the set ID will be cleared.

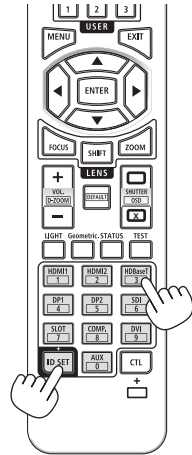

FREEZE

Changes the projected video to a still image.

TIP:

- The image being projected when the picture was frozen is stored in the memory and the image in the memory (a still picture) is projected. While the still picture is displayed, the video of the Blu-ray player or other device continues to play.

TRIGGER

Set whether to output the control voltage for screen control from the screen trigger terminal according to the input video signal.

STANDBY TIMER

Select whether to immediately set the standby mode or to set a waiting time when the operation to turn off the power is performed.

OFF	The standby mode is set immediately when the operation to turn off the power is performed.
ON	Even when the operation to turn off the power is performed, the standby mode is not set and the light source is turned off for the amount of time set with [OFF TIMER].

NOTE:

- [STANDBY TIMER] will not be changed even if [RESET] is performed.
-

OFF TIMER

Set the waiting time from when the operation to turn off the power is performed until the standby mode is set.

This can be selected when [STANDBY TIMER] is set to [ON].

NOTE:

- [OFF TIMER] will not be changed even if [RESET] is performed.
-

NETWORK SETTINGS

Configure the network settings of the projector.

• WIRED LAN

DHCP	ON	The DHCP server automatically assigns an IP address, subnet mask and gateway.
	OFF	Manually set an arbitrary IP address or subnet mask assigned by the network administrator.
IP ADDRESS	<p>When [DHCP] is set to [OFF], this sets the IP address of the projector in the network which it is connected to. Use the following procedure to change the IP address.</p> <ol style="list-style-type: none"> 1. Move the cursor to the IP address and press the button. Mode changes to the edit mode. 2. Press the ◀/▶ button to select a number. 3. Press the ▼/▲ button to increase or decrease the number. 4. Press the ENTER button to confirm. 	
SUBNET MASK	When [DHCP] is set to [OFF], this sets the subnet mask of the projector in the network which it is connected to.	
GATEWAY	When [DHCP] is set to [OFF], this sets the default gateway of the network the projector is connected to. Refer to the [IP ADDRESS] item for details on how to change the gateway.	
DNS CONFIGURATION	Set the IP address of the DNS server of the network the projector is connected to. Refer to the [IP ADDRESS] item for details on how to change the DNS.	
MAC ADDRESS	Displays the MAC address of the projector.	
RECONNECT	Try connecting to the network.	

NOTE:

- [WIRED LAN] will not be changed even if [RESET] is performed.

• AMX BEACON

If you connect the projector to a network compatible with the NetLinx control system of AMX Corporation, you can enable/disable the detection setting from AMX Device Discovery.

ON	Enables the detection of the projector from AMX Device Discovery.
OFF	Disables the detection of the projector from AMX Device Discovery.

TIP:

- AMX Device Discovery is a function to automatically detect a compatible device when it is connected and download the Device Discovery Module required for control from the AMX server.

4-7. SETUP(2)

POWER OPTIONS

• STANDBY MODE

Select the standby mode.

POWER-SAVING	This setting is to keep the standby power consumption to the minimum necessary.
LAN	When the projector is in the standby mode, it can be operated using a wired LAN connection.
HDBaseT	When the projector is in the standby mode, it can be operated using an HDBaseT-compatible transmitter connected to the HDBaseT port.

NOTE:

- [STANDBY MODE] will not be changed even if [RESET] is performed.

• AUTO POWER OFF

If there is no signal input or no operation has been carried out for a certain period of time, the power of the projector will automatically turn off.

• DIRECT POWER ON

Set the projector to turn on automatically when AC power is supplied to it. Use this when you want to control the projector with a control console etc.

OFF	When AC power is supplied, the projector goes into the standby mode.
ON	Projects the signal from the input terminal that was projected when the power was last turned off. TIP: <ul style="list-style-type: none"> • When [AUTO SOURCE] is turned to [ON] and [DIRECT POWER ON] turns [ON], [AUTO SOURCE] is activated.

WARNING

- The projector produces intense light. When turning on the power, make sure no one within the projection range is looking at the lens.

BACKGROUND

Select the background color when there is no input signal.

You can select either blue, black, or the logo.

See "Registering a background logo" (→page 117) for how to register an image as a logo.

MENU

STARTUP LOGO	Select the background color to be displayed when the projector starts.
MENU POSITION	Changes the position to display the menu. You can choose from 5 locations.
MENU TRANSLUCENT	Select the menu transparency.
DISPLAY TIME	Select the time until the menu is automatically closed when the menu is displayed and no button is pressed next.
MESSAGE DISPLAY	Select whether or not to display the projector's message at the bottom of the projection screen.
MENU ANGLE	Select the direction for displaying the menu.

IMAGE MEMORY

Up to four settings related to picture quality can be stored in the projector's memory.

[Settings that can be saved]

HDMI EQUALIZER, COLOR SPACE, NOISE REDUCTION, PRESET, BRIGHTNESS, CONTRAST, COLOR CORRECTION, SATURATION, HUE, SHARPNESS, GAMMA, COLOR GAMUT, COLOR TEMPERATURE, INPUT BALANCE, HDR MODE, ASPECT RATIO, OVERSCAN, DYNAMIC CONTRAST, LIGHT OFF TIMER

Move the cursor to number 1, 2, 3, or 4 in [STORE], then press the ENTER or ► button to save the settings.

To load the saved settings, select number 1, 2, 3, or 4 in [LOAD] and press the ENTER or ► button. Select [RESET] to return the above settings to the factory default. The data saved in slots 1 through 4 will not be deleted.

LANGUAGE

Select the language to be displayed in the menu.

RESET

All adjustment values and setting values stored in the projector will be reset to the factory settings. The reset process takes some time to run.

Data that cannot be reset

SMOOTH PICTURE, ORIENTATION, LENS CONTROL, LENS MEMORY, LENS CALIBRATION, FAN MODE, STANDBY TIMER, OFF TIMER, WIRED LAN, STANDBY MODE

4-8. INFO.

MODEL NO.	Displays the model name.
SERIAL NUMBER	Displays the serial number.
VERSION	Displays the firmware version number.
LIGHT HOURS USED	Displays the light hours used.
SOURCE	Displays the information for the signal currently being projected.
SYSTEM STATUS	Displays the projector's status.
THERMAL STATUS	Displays the temperature of the air inlet, the temperature inside the projector, the rpm of the cooling fan, and the rpm of the water cooling pump.

5. Attachment/detachment of lens unit

Six separate bayonet style lenses can be used with this projector. The descriptions here are for the XP-61ZL lens. Mount other lenses in the same manner.

After installing or replacing the lens unit, press the LENS CALIBRATION button on the projector to carry out [LENS CALIBRATION]. By carrying out [LENS CALIBRATION], the lens unit and lens shift adjustment range are calibrated.

WARNING:

(1) Turn off the power and wait for the cooling fan to stop, (2) disconnect the power cord and wait for the unit to cool before mounting or removing the lens. Failure to do so can result in eye injury, electric shock, or burn injuries.

Important:

- The projector and lenses are made of precision parts. Do not subject them to shock or excessive forces.
- Remove the separately sold lens when moving the projector. If not, the lens could be subject to shock while the projector is being moved, damaging the lens and the lens shift mechanism.
- If the projector must be moved with the lens unit attached, such as when it is installed in a high or specific location, use the screws included with the lens unit to secure it to the projector. Do not hold the lens when moving the projector.
- When dismantling the lens from the projector, return the lens position to the home position before turning off the power. Failure to do so may prevent the lens from being mounted or dismantled because of narrow space between the projector and the lens.
- Never touch the lens surface while the projector is operating.
- Be very careful not to let dirt, grease, etc., on the lens surface and not to scratch the lens surface.
- Perform these operations on a flat surface over a piece of cloth, etc., to prevent the lens from getting scratched.
- When leaving the lens off the projector for long periods of time, mount the dust cap on the projector to prevent dust or dirt from getting inside.

Items to prepare

Ball point hexagon wrench driver (2.5mm)

Mounting the lens

1. Remove the dust cap from the projector.

Push the tongue at the top left outward and pull the knob at the center of the cap.

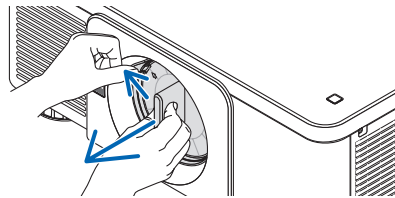

2. Remove the lens cap on the back of the lens.

NOTE:

- Make sure to remove the lens cap at the unit back side. If the lens unit with the lens cap remaining on is installed on the projector, it may cause malfunction.

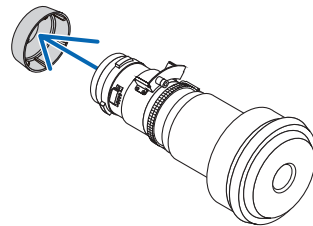

5. Attachment/detachment of lens unit

3. **Hold the lens unit aligning the labelled arrow on the unit coming top and insert the unit to the projector.**

Insert the lens slowly all the way in, keeping the positioning slit at the same angle.

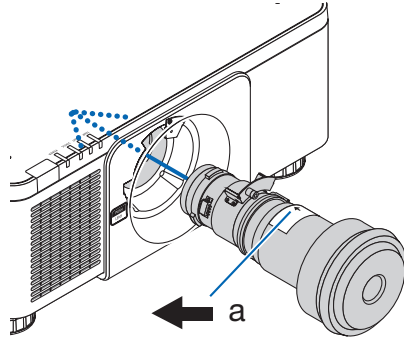

a: Arrow mark

4. **Turn the lens unit rightward until click is heard.**

The lens is now fastened onto the projector.

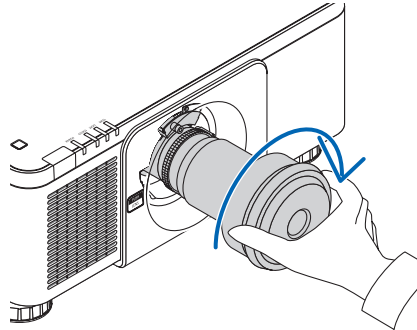

5. **Use a ball point hexagon wrench driver to turn lens unit screw ③ clockwise to tighten.**

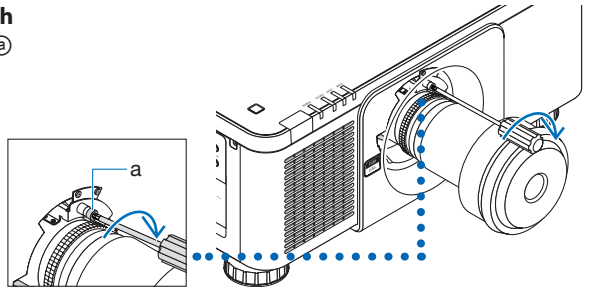

Removing the lens

Before removing the lens:

1. Turn on the projector and display an image.
2. Press the LENS CALIBRATION button.
The lens position will be moved to the home position.
3. Turn off the projector, and then unplug the power cord.
4. Mount the lens cap on the lens.
5. Wait until the projector cabinet is cool enough to handle.

1. To untighten, use a ball point hexagon wrench driver to turn the lens unit screw **a** counterclockwise until it rotates freely.

The screws cannot be removed.

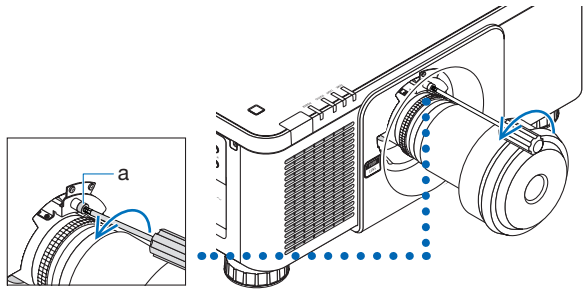

2. While pressing the LENS release button on the projector's front panel fully in, turn the lens counterclockwise.

The lens comes off.

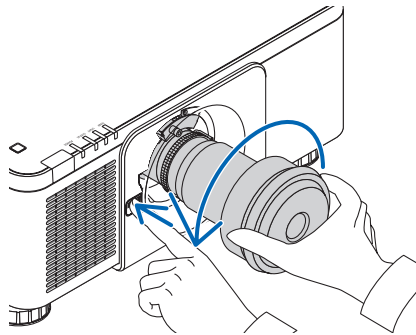

3. After slowly pulling the lens off the projector, release the LENS release button.

- After removing the lens, mount the lens caps (front and back) included with the lens before storing the lens.
- If no lens is going to be mounted on the projector, mount the dust cap included with the projector.

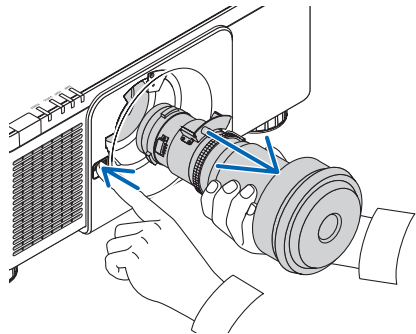

5. Attachment/detachment of lens unit

To attach the dust cap to the projector, locate the catch on the lower end of the dust cap and place it into the opening of the projector with the point of a triangle mark (▽) facing downward (① in the figure below), and then push the upper end of the dust cap against the projector to place the catches into the slot while clutching the handle (② in the figure below).

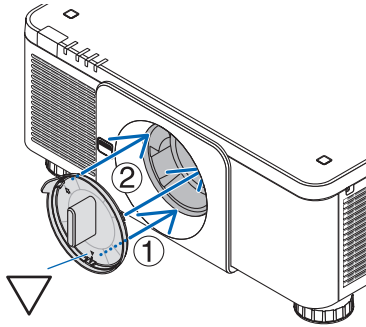

6. Connecting to Other Equipment



CAUTION

- Be sure to turn off the projector before connecting the projector to an external device. If projected light enters your eyes, it may cause visual impairment.

NOTE:

- The connection cable is not enclosed with the projector. Please get ready a suitable cable for the connection. For HDMI, LAN, BNC, RS-232C, and DisplayPort, please use a shielded signal cable. Use of other cables and adapters may cause interference with radio and television reception.
-

6-1. Connecting to a computer or video device

Below are examples of connection to a computer or video device.

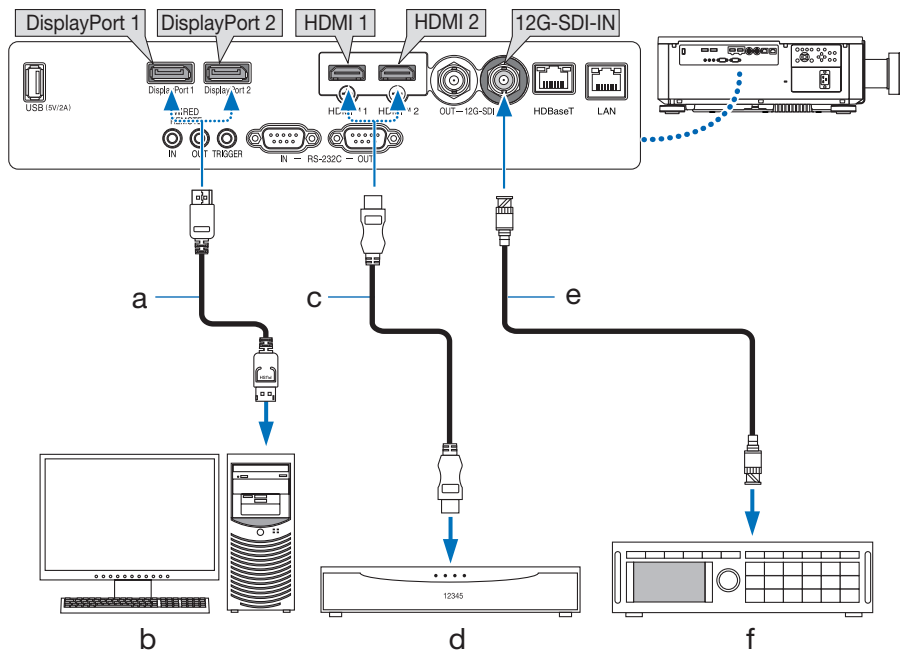

a: DisplayPort cable (not supplied)

- Use a certified DisplayPort cable, and the length is up to 5 m.

b: Computer, etc.

c: HDMI cable (not supplied)

- Use a Premium High Speed HDMI Cable, and the length is up to 15 m. (The maximum distance is 5 m for a 4K signal)

d: Blu-ray player, etc.

e: BNC cable (not supplied)

- Use a 12G-SDI compatible CANARE cable, and the length is up to 80 m.

f: Professional video devices, etc.

- It supports 12G.

6-2. Connecting to a HDBaseT transmission device (sold commercially)

Use a LAN cable sold commercially to connect the HDBaseT port of the projector to a HDBaseT transmission device sold commercially.

The HDBaseT port of the projector supports HDMI signals (HDCP) from transmission devices, control signals from external devices (serial, LAN) and remote control signals (IR commands).

- Refer to the owner's manual accompanied with your HDBaseT transmission for connecting with your external devices.

Connection example

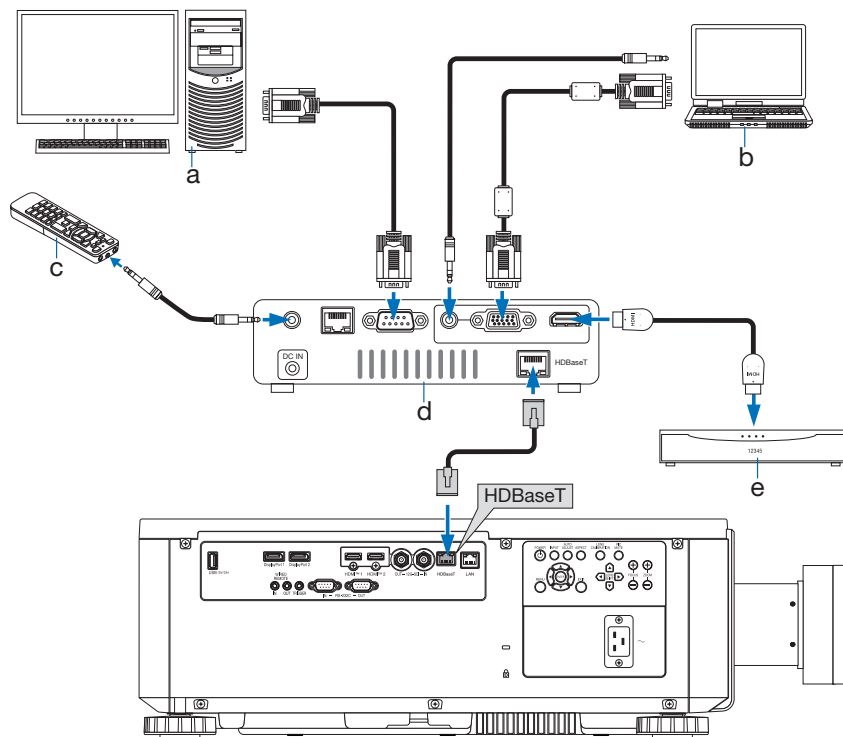

a: Computer (for control use) / b: Computer (for output use) / c: Remote control /
d: Example of a transmission device / e: HDMI output video device

NOTE:

- Use a shielded twisted pair (STP) cable of Category 6A or higher for the LAN cable (sold commercially), and the length is up to 80 m.
- Please do not use other transmission equipment between the projector and transmission equipment. The picture quality may be degraded as a result.
- This projector is not guaranteed to work with all HDBaseT transmission devices sold commercially.

6-3. Connecting to a Wired LAN

The projector comes standard with a LAN port which provides a LAN connection using a LAN cable. To use a LAN connection, you are required to set the LAN on the projector menu. Select [SETUP(1)] → [NETWORK SETTINGS] → [WIRED LAN]. (→ page 71).

Example of LAN connection

Example of wired LAN connection

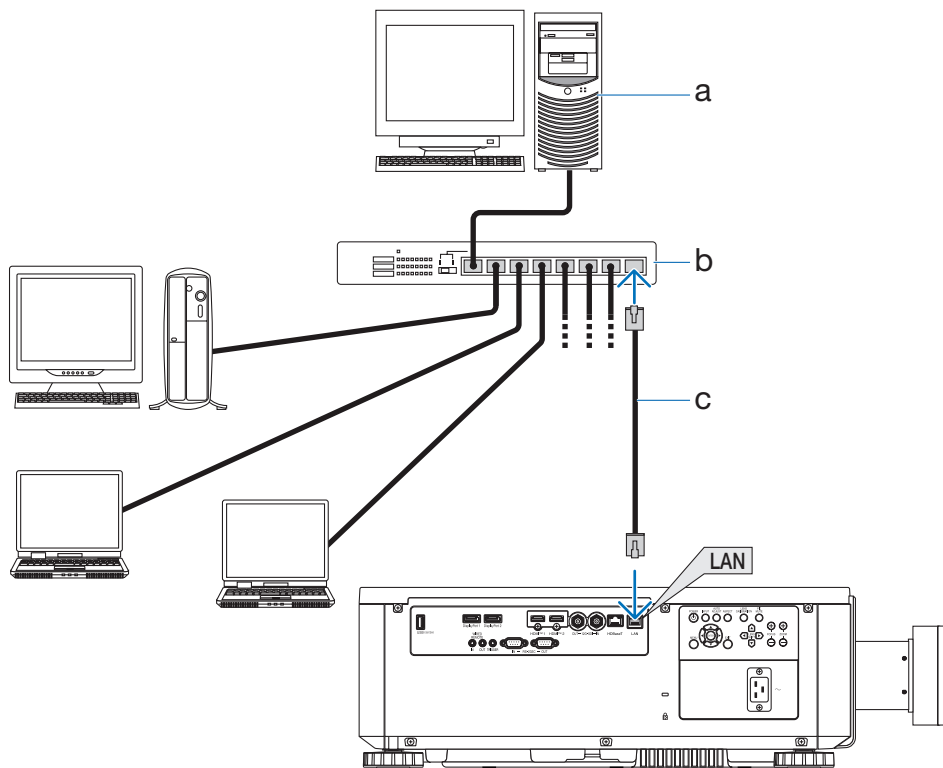

a: Server / b: Hub / c: LAN cable (not supplied) (Use a shielded twisted pair (STP) cable of Category 5e or higher for the LAN cable.)

7. Maintenance

7-1. Cleaning the Lens

 **WARNING**

- Turn off the power, unplug the power plug from the socket and remove the lens for cleaning. If the unit turns on while cleaning the lens, the strong light from the lens could damage your eyes. It could also burn your fingers.
- Please do not use a spray containing flammable gas to remove dust attached to the lens. Doing so may result in fires.

Use a commercially available plastic lens cleaner.
Never use alcohol. It may cause damage to the lens surface.

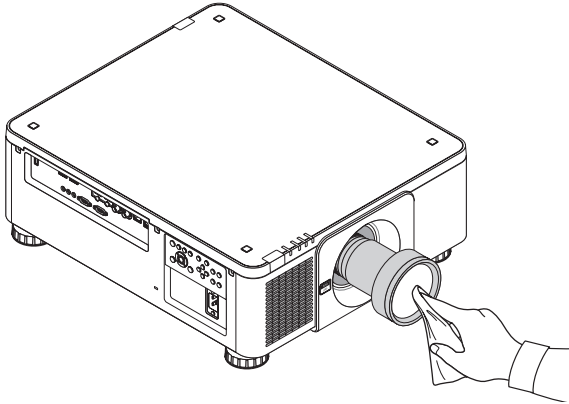

7-2. Cleaning the Cabinet

WARNING

- Turn off the projector, and unplug the projector before cleaning.
 - Please do not use a spray containing flammable gas to remove dust attached to the cabinet. Doing so may result in fires.
-
- Use a dry soft cloth to wipe dust off the cabinet.
If heavily soiled, use a mild detergent.
 - Never use strong detergents or solvents such as alcohol or thinner.
 - When cleaning the ventilation slits using a vacuum cleaner, do not force the brush of the vacuum cleaner into the slits of the cabinet.

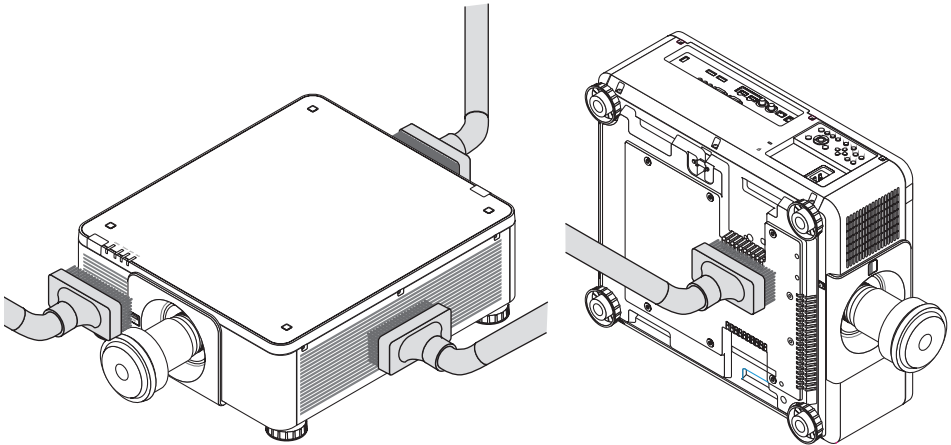

Vacuum the dust off the ventilation slits.

- Poor ventilation caused by dust accumulation in ventilation openings (also at the bottom of the projector) can result in overheating and malfunction. These areas should be cleaned regularly.
- Do not scratch or hit the cabinet with your fingers or any hard objects
- Contact your dealer for cleaning the inside of the projector.

NOTE:

- Do not apply volatile agent such as insecticide on the cabinet, the lens, or the screen. Do not leave a rubber or vinyl product in prolonged contact with it. Otherwise the surface finish will be deteriorated or the coating may be stripped off.

8. Appendix

8-1. Throw distance and screen size

Six separate bayonet style lenses can be used on this projector. Refer to the information on this page and use a lens suited for the installation environment (screen size and throw distance).

Projection range for the different lenses

(Recommended distance from projector to screen)

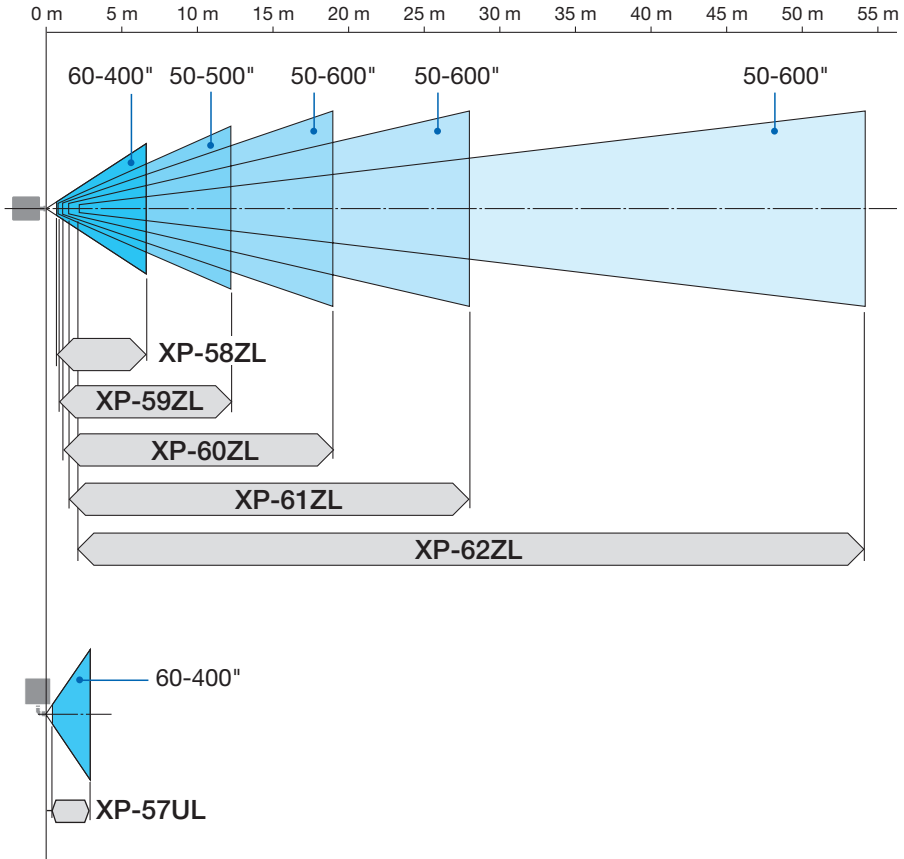

Lens types and throw distance (Aspect ratio 16:10)

(Unit: inch)

Screen size	Width × Height (inches)	Lens model name and throw distance					
		XP-57UL	XP-58ZL	XP-59ZL	XP-60ZL	XP-61ZL	XP-62ZL
50	42 × 26	–	–	29.7 – 44.8	41.9 – 58.4	57.7 – 88.2	88.3 – 169.3
60	51 × 32	15.1 – 16.2	27.3 – 37.4	36.3 – 54.5	51.2 – 70.9	69.9 – 106.6	106.2 – 205.0
80	68 × 42	20.7 – 22.2	36.8 – 50.4	49.5 – 73.8	69.7 – 95.9	94.3 – 143.3	142.2 – 276.4
100	85 × 53	26.3 – 28.2	46.4 – 63.4	62.8 – 93.2	88.2 – 120.9	118.7 – 179.9	178.1 – 347.9
120	102 × 64	31.9 – 34.2	56.0 – 76.5	76.0 – 112.5	106.7 – 145.9	143.1 – 216.6	214.0 – 419.3
150	127 × 79	40.3 – 43.3	70.3 – 96.0	95.9 – 141.5	134.4 – 183.4	179.7 – 271.6	267.9 – 526.4
200	170 × 106	54.2 – 58.3	94.2 – 128.6	129.0 – 189.9	180.7 – 245.9	240.7 – 363.3	357.7 – 705.0
240	204 × 127	65.4 – 70.4	113.3 – 154.7	155.4 – 228.5	217.7 – 295.8	289.5 – 436.7	429.5 – 847.8
300	254 × 159	82.2 – 88.4	142.0 – 193.8	195.1 – 286.5	273.2 – 370.8	362.7 – 546.7	537.3 – 1062.1
400	339 × 212	110.1 – 118.6	189.8 – 258.9	261.3 – 383.2	365.7 – 495.8	484.7 – 730.1	716.9 – 1419.2
500	424 × 265	–	–	327.5 – 479.9	458.2 – 620.7	606.7 – 913.5	896.5 – 1776.4
600	509 × 318	–	–	–	550.8 – 745.7	728.7 – 1096.9	1076.1 – 2133.5

(Unit: m)

Screen size	Width × Height (cm)	Lens model name and throw distance					
		XP-57UL	XP-58ZL	XP-59ZL	XP-60ZL	XP-61ZL	XP-62ZL
50	107.7 × 67.3	–	–	0.8 – 1.1	1.1 – 1.5	1.5 – 2.2	2.2 – 4.3
60	129.2 × 80.8	0.4 – 0.4	0.7 – 0.9	0.9 – 1.4	1.3 – 1.8	1.8 – 2.7	2.7 – 5.2
80	172.3 × 107.7	0.5 – 0.6	0.9 – 1.3	1.3 – 1.9	1.8 – 2.4	2.4 – 3.6	3.6 – 7.0
100	215.4 × 134.6	0.7 – 0.7	1.2 – 1.6	1.6 – 2.4	2.2 – 3.1	3.0 – 4.6	4.5 – 8.8
120	258.5 × 161.5	0.8 – 0.9	1.4 – 1.9	1.9 – 2.9	2.7 – 3.7	3.6 – 5.5	5.4 – 10.6
150	323.1 × 201.9	1.0 – 1.1	1.8 – 2.4	2.4 – 3.6	3.4 – 4.7	4.6 – 6.9	6.8 – 13.4
200	430.8 × 269.2	1.4 – 1.5	2.4 – 3.3	3.3 – 4.8	4.6 – 6.2	6.1 – 9.2	9.1 – 17.9
240	516.9 × 323.1	1.7 – 1.8	2.9 – 3.9	3.9 – 5.8	5.5 – 7.5	7.4 – 11.1	10.9 – 21.5
300	646.2 × 403.9	2.1 – 2.2	3.6 – 4.9	5.0 – 7.3	6.9 – 9.4	9.2 – 13.9	13.6 – 27.0
400	861.6 × 538.5	2.8 – 3.0	4.8 – 6.6	6.6 – 9.7	9.3 – 12.6	12.3 – 18.5	18.2 – 36.0
500	1077.0 × 673.1	–	–	8.3 – 12.2	11.6 – 15.8	15.4 – 23.2	22.8 – 45.1
600	1292.3 × 807.7	–	–	–	14.0 – 18.9	18.5 – 27.9	27.3 – 54.2

Lens types and throw distance (Aspect ratio 16:9)

(Unit: inch)

Screen size	Width × Height (inches)	Lens model name and throw distance					
		XP-57UL	XP-58ZL	XP-59ZL	XP-60ZL	XP-61ZL	XP-62ZL
50	44 × 27	–	–	30.6 – 46.2	43.2 – 60.2	59.4 – 90.8	90.8 – 174.3
60	52 × 33	15.6 – 16.7	28.1 – 38.5	37.4 – 56.1	52.7 – 73.0	71.9 – 109.6	109.2 – 211.0
80	70 × 44	21.3 – 22.8	37.9 – 51.9	51.0 – 76.0	71.7 – 98.7	97.0 – 147.3	146.2 – 284.4
100	87 × 54	27.1 – 29.0	47.7 – 65.3	64.6 – 95.8	90.7 – 124.4	122.1 – 185.0	183.1 – 357.8
120	105 × 65	32.8 – 35.2	57.6 – 78.6	78.2 – 115.7	109.8 – 150.1	147.2 – 222.7	220.0 – 431.2
150	131 × 82	41.4 – 44.5	72.3 – 98.7	98.6 – 145.5	138.3 – 188.6	184.8 – 279.3	275.4 – 541.3
200	174 × 109	55.8 – 60.0	96.9 – 132.2	132.6 – 195.2	185.8 – 252.8	247.5 – 373.5	367.7 – 724.8
240	209 × 131	67.3 – 72.4	116.5 – 159.0	159.8 – 235.0	223.9 – 304.2	297.7 – 448.9	441.5 – 871.7
300	261 × 163	84.5 – 90.9	146.0 – 199.2	200.7 – 294.6	280.9 – 381.2	372.9 – 562.0	552.3 – 1091.9
400	349 × 218	–	–	268.7 – 394.0	376.0 – 509.7	498.3 – 750.5	736.9 – 1459.0
500	436 × 272	–	–	–	471.1 – 638.1	623.7 – 939.0	921.5 – 1826.0
600	523 × 327	–	–	–	–	–	–

(Unit: m)

Screen size	Width × Height (cm)	Lens model name and throw distance					
		XP-57UL	XP-58ZL	XP-59ZL	XP-60ZL	XP-61ZL	XP-62ZL
50	110.7 × 62.3	–	–	0.8 – 1.2	1.1 – 1.5	1.5 – 2.3	2.3 – 4.4
60	132.8 × 74.7	0.4 – 0.4	0.7 – 1.0	1.0 – 1.4	1.3 – 1.9	1.8 – 2.8	2.8 – 5.4
80	177.1 × 99.6	0.5 – 0.6	1.0 – 1.3	1.3 – 1.9	1.8 – 2.5	2.5 – 3.7	3.7 – 7.2
100	221.4 × 124.5	0.7 – 0.7	1.2 – 1.7	1.6 – 2.4	2.3 – 3.2	3.1 – 4.7	4.6 – 9.1
120	265.7 × 149.4	0.8 – 0.9	1.5 – 2.0	2.0 – 2.9	2.8 – 3.8	3.7 – 5.7	5.6 – 11.0
150	332.1 × 186.8	1.1 – 1.1	1.8 – 2.5	2.5 – 3.7	3.5 – 4.8	4.7 – 7.1	7.0 – 13.7
200	442.8 × 249.1	1.4 – 1.5	2.5 – 3.4	3.4 – 5.0	4.7 – 6.4	6.3 – 9.5	9.3 – 18.4
240	531.3 × 298.9	1.7 – 1.8	3.0 – 4.0	4.1 – 6.0	5.7 – 7.7	7.6 – 11.4	11.2 – 22.1
300	664.1 × 373.6	2.1 – 2.3	3.7 – 5.1	5.1 – 7.5	7.1 – 9.7	9.5 – 14.3	14.0 – 27.7
400	885.5 × 498.1	–	–	6.8 – 10.0	9.6 – 12.9	12.7 – 19.1	18.7 – 37.1
500	1106.9 × 622.6	–	–	–	12.0 – 16.2	15.8 – 23.9	23.4 – 46.4
600	1328.3 × 747.2	–	–	–	–	–	–

Calculation of the throw distance from the screen size

L: Throw distance W: Screen width

Lens model name	Calculation formula (Zoom min to max)
XP-57UL	$L = W \times 0.31$ to $W \times 0.33$
XP-58ZL	$L = W \times 0.5$ to $W \times 0.7$
XP-59ZL	$L = W \times 0.7$ to $W \times 1.1$
XP-60ZL	$L = W \times 1.0$ to $W \times 1.4$
XP-61ZL	$L = W \times 1.4$ to $W \times 2.1$
XP-62ZL	$L = W \times 2.1$ to $W \times 4.0$

Example: Throw distance when projecting on a 16:10 150" screen using the XP-61ZL lens: According to the "Lens types and throw distance (Aspect ratio 16:10)" table (→ page 86), W (screen width) = 127"/323.1 cm.

The throw distance is $127"/323.1 \text{ cm} \times 1.4$ to $127"/323.1 \text{ cm} \times 2.1 = 178"/452.3 \text{ cm}$ to $267"/678.5 \text{ cm}$ (because of the zoom lens).

* Your calculated figure has a few percent margin of error because the calculation formula is approximate.

Lens shifting range

This projector is equipped with a lens shift function for adjusting the position of the projected image by buttons. The lens can be shifted within the range shown below.

- See page 25 for lens shift operations and precautions.

Description of symbols: V indicates vertical (height of the projected image), H indicates horizontal (width of the projected image).

Desk/front projection

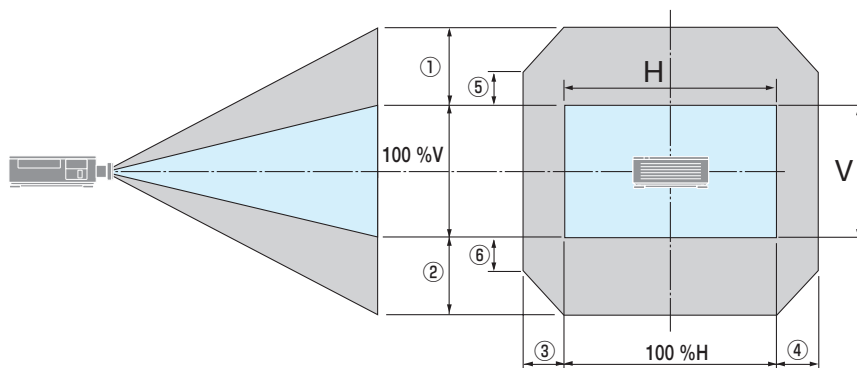

Ceiling/front projector

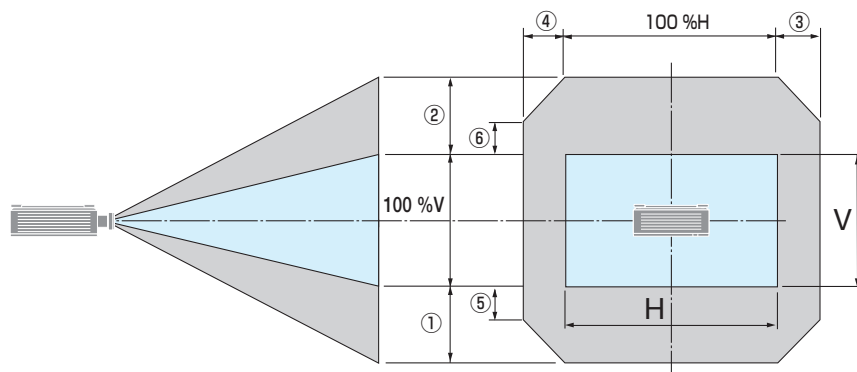

Number in the figure	Lens Unit					
	XP-57UL	XP-58ZL	XP-59ZL	XP-60ZL	XP-61ZL	XP-62ZL
① ②	50%V			60%V		
③ ④	-	20%H				
⑤ ⑥	-	10%V		25%V		

Example: When projecting on a 16:10 150" screen using the XP-61ZL lens:

According to the "Lens types and throw distance (Aspect ratio 16:10)" (→ page 86), H (screen width) = 323.1 cm and V (screen height) = 201.9 cm

Adjustment range in the vertical direction: Upper and lower directions of $0.60 \times 201.9 \text{ cm} \approx 121 \text{ cm}$ possible movement of the projected screen (when the lens is at the center position).

Adjustment range in the horizontal direction: Right and left directions of $0.20 \times 323.1 \text{ cm} \approx 65 \text{ cm}$ possible movement of the projected screen.

* Your calculated figure has a few percent margin of error because the calculation formula is approximate.

8-2. Compatible Input Signal List

HDMI

Signal	Resolution (dots)	Aspect Ratio	Refresh Rate (Hz)	Bit Depth	Signal Type
VGA	640 × 480	4 : 3	60	8	RGB
SVGA	800 × 600	4 : 3	60	8	RGB
XGA	1024 × 768	4 : 3	60	8	RGB
HD	1280 × 720	16 : 9	60	8	RGB
WXGA	1280 × 768	15 : 9	60	8	RGB
	1280 × 800	16 : 10	60	8	RGB
Quad-VGA	1280 × 960	4 : 3	60	8	RGB
SXGA	1280 × 1024	5 : 4	60	8	RGB
FWXGA	1366 × 768	16 : 9	60	8	RGB
SXGA+	1400 × 1050	4 : 3	60	8	RGB
WXGA+	1440 × 900	16 : 10	60	8	RGB
WSXGA+	1680 × 1050	16 : 10	60	8	RGB
UXGA	1600 × 1200	4 : 3	60	8	RGB
Full HD	1920 × 1080	16 : 9	60	8	RGB
WUXGA	1920 × 1200	16 : 10	60 Reduce Blanking	8	RGB
2K	2048 × 1080	16 : 9	24/25/30/50/60	8/10/12	RGB/ YCbCr4:4:4/ YCbCr4:2:2
4KUHD	3840 × 2160	16 : 9	24/25/30	8/10/12	RGB/ YCbCr4:4:4/ YCbCr4:2:2
			50/60	8	RGB/ YCbCr4:4:4/ YCbCr4:2:2
				10/12	YCbCr4:2:2/ YCbCr4:2:0
4K+	3840 × 2400	16 : 10	24/25/30/50/60 Reduce Blanking	8/10/12	RGB/ YCbCr4:4:4/ YCbCr4:2:2
HDTV (1080p)	1920 × 1080	16 : 9	24/25/30/50/60	8/10/12	RGB/ YCbCr4:4:4/ YCbCr4:2:2
HDTV (1080i)	1920 × 1080	16 : 9	50/60	8/10/12	RGB/ YCbCr4:4:4/ YCbCr4:2:2
HDTV (720p)	1280 × 720	16 : 9	50/60	8/10/12	RGB/ YCbCr4:4:4/ YCbCr4:2:2

HDBaseT

Signal	Resolution (dots)	Aspect Ratio	Refresh Rate (Hz)	Bit Depth	Signal Type
VGA	640 × 480	4 : 3	60	8	RGB
SVGA	800 × 600	4 : 3	60	8	RGB
XGA	1024 × 768	4 : 3	60	8	RGB
HD	1280 × 720	16 : 9	60	8	RGB
WXGA	1280 × 768	15 : 9	60	8	RGB
	1280 × 800	16 : 10	60	8	RGB
Quad-VGA	1280 × 960	4 : 3	60	8	RGB
SXGA	1280 × 1024	5 : 4	60	8	RGB
FWXGA	1366 × 768	16 : 9	60	8	RGB
SXGA+	1400 × 1050	4 : 3	60	8	RGB
WXGA+	1440 × 900	16 : 10	60	8	RGB
WSXGA+	1680 × 1050	16 : 10	60	8	RGB
UXGA	1600 × 1200	4 : 3	60	8	RGB
Full HD	1920 × 1080	16 : 9	60	8	RGB
WUXGA	1920 × 1200	16 : 10	60 Reduce Blanking	8	RGB
2K	2048 × 1080	16 : 9	24/25/30/50/60	8/10/12	RGB/ YCbCr4:4:4/ YCbCr4:2:2
4KUHD	3840 × 2160	16 : 9	24/25/30	8/10/12	YCbCr4:2:2
			50/60	8	YCbCr4:2:0
HDTV (1080p)	1920 × 1080	16 : 9	24/25/30/50/60	8/10/12	RGB/ YCbCr4:4:4/ YCbCr4:2:2
HDTV (1080i)	1920 × 1080	16 : 9	50/60	8/10/12	RGB/ YCbCr4:4:4/ YCbCr4:2:2
HDTV (720p)	1280 × 720	16 : 9	50/60	8/10/12	RGB/ YCbCr4:4:4/ YCbCr4:2:2

SDI

Signal	Resolution (dots)	Aspect Ratio	Refresh Rate (Hz)	Bit Depth	Signal Type
HD-SDI (1080p)	1920 × 1080	16 : 9	24/25/30	10	YCbCr4:2:2
HD-SDI (1080i)	1920 × 1080	16 : 9	50/60	10	YCbCr4:2:2
HD-SDI (1080sF)	1920 × 1080	16 : 9	25/30	10	YCbCr4:2:2
HD-SDI (720p)	1280 × 720	16 : 9	50/60	10	YCbCr4:2:2
3G-SDI Level A (1080p)	1920 × 1080	16 : 9	50/60	10	YCbCr4:2:2
12G-SDI Single Link-2SI (2160p)	3840 × 2160	16 : 9	24/25/30	10/12	YCbCr4:4:4/ YCbCr4:2:2
			50/60	10	YCbCr4:2:2
	4096 × 2160	17 : 9	24/25/30	10/12	YCbCr4:4:4/ YCbCr4:2:2
			50/60	10	YCbCr4:2:2

DisplayPort

Signal	Resolution (dots)	Aspect Ratio	Refresh Rate (Hz)	Bit Depth	Signal Type
VGA	640 × 480	4 : 3	60	8	RGB
SVGA	800 × 600	4 : 3	60	8	RGB
XGA	1024 × 768	4 : 3	60	8	RGB
HD	1280 × 720	16 : 9	60	8	RGB
WXGA	1280 × 768	15 : 9	60	8	RGB
	1280 × 800	16 : 10	60	8	RGB
Quad-VGA	1280 × 960	4 : 3	60	8	RGB
SXGA	1280 × 1024	5 : 4	60	8	RGB
FWXGA	1366 × 768	16 : 9	60	8	RGB
SXGA+	1400 × 1050	4 : 3	60	8	RGB
WXGA+	1440 × 900	16 : 10	60	8	RGB
WSXGA+	1680 × 1050	16 : 10	60	8	RGB
UXGA	1600 × 1200	4 : 3	60	8	RGB
Full HD	1920 × 1080	16 : 9	60	8	RGB
WUXGA	1920 × 1200	16 : 10	60 Reduce Blanking	8	RGB
2K	2048 × 1080	16 : 9	24/25/50/60	8/10/12	RGB
4KUHD	3840 × 2160	16 : 9	24/25/30	8/10/12	RGB
			50/60	8	RGB
4K+	3840 × 2400	16 : 10	24/25/30/50/60 Reduce Blanking	8/10/12	RGB
HDTV (1080p)	1920 × 1080	16 : 9	24/25/30/50/60	8/10/12	RGB
HDTV (1080i)	1920 × 1080	16 : 9	50/60	8/10/12	RGB
HDTV (720p)	1280 × 720	16 : 9	50/60	8/10/12	RGB

- With Advanced AccuBlend, the size of characters and ruled lines may be uneven and colors may be blurred.
- Upon shipment, the projector is set for signals with standard display resolutions and frequencies, but adjustments may be required depending on the type of computer.

8-3. Specifications

Model name		X171Q-B/X171Q-W	X141Q-B/X141Q-W
Method		Single DLP® chip	
Resolution		9,216,000 pixels (3840 dots × 2400 lines)	
Specifications of main parts			
DMD panel	Size	0.8" (aspect ratio: 16:10)	
	Pixels ^{(*)1}	2,304,000 (1920 dots × 1200 lines)	
Projection lenses	Refer to the specifications of option lens (→ 96 page)		
	Zoom	Motorized	
	Focus	Motorized	
	Lens shifting	Motorized	
Light source		Laser diode with Phosphor	
Light output ^{(*)2) (*)3}		16500 lm (100 - 130 VAC: 14000 lm)	13500 lm
Screen size (throw distance)		50"–600" (Throw distance depends on the lens)	
Color reproducibility		10-bit color processing (approx. 1.07 billion colors)	
Scanning frequency	Horizontal	15 kHz, 24 to 153 kHz	
	Vertical	24, 25, 30, 48 Hz, 50 to 85 Hz, 100, 120 Hz	
Input/output connectors			
HDMI 1/2	Video input	Type A × 2 Deep Color, LipSync, HDCP ^{(*)4} , 4K	
HDBaseT	Video input	RJ-45 x1, Deep Color, LipSync, HDCP ^{(*)4} , 4K	
	Control	100BASE-TX, PLink class1	
SDI IN	Video input	BNC x1 12G	
SDI OUT	Video output	BNC x1 12G	
DisplayPort 1/2	Video input	DisplayPort × 2 Deep Color, LipSync, HDCP ^{(*)4} , 4K	
USB		USB type A × 1, 5.0 V/2.0 A power supply	
Control Terminals	LAN	RJ-45 × 1, 10BASE-T/100BASE-TX, PLink class1	
	RS-232C IN	D-Sub 9-pin × 1	
	RS-232C OUT	D-Sub 9-pin × 1	
	WIRED REMOTE IN	Stereo mini jack × 1	
	WIRED REMOTE OUT	Stereo mini jack × 1	
	TRIGGER	Stereo mini jack × 1	
Built-in Speaker		Not applicable	
Usage environment ^{(*)5}		Operating temperature: 32 to 113°F (0 to 45°C) Operating humidity: 20 to 80% (with no condensation) Storage temperature: 14 to 140°F (–10 to 60°C) Storage humidity: 20 to 80% (with no condensation) Operating altitude: 0 to 3000 m/10000 feet (1499 - 3000 m / 5000 - 10000 feet : Set [FAN MODE] to [HIGH])	

Model name		X171Q-B/X171Q-W	X141Q-B/X141Q-W
Power supply		100-240 VAC, 50/60 Hz	
Power consumption		1080 W (100-130VAC) 1290 W (200-240VAC)	1080 W (100-240 VAC)
Power consumption (Standby state)	Network enabled	2.0 W (100-240 VAC)	
	Network disabled	0.5 W (100-240 VAC)	
Rated input current		12.0 A (100-130VAC) – 6.0 A (200-240VAC)	10.0 A (100-130 VAC) – 5.0 A (200-240 VAC)
Power cord specification		15 A or higher	
External dimensions		19.7" (width) × 8.3" (height) × 22.7" (depth)/ 500 mm (width) × 211 mm (height) × 577 mm (depth) (not including protruding parts)	
		19.7" (width) × 8.5" (height) × 23.0" (depth)/ 500 mm (width) × 216 mm (height) × 583 mm (depth) (including protruding parts)	
Weight		65.5 lbs/29.7 kg (not including lens)	64.8 lbs/29.4 kg (not including lens)

- *1 Effective pixels are more than 99.99%.
- *2 This is the brightness when lens unit XP-61ZL (sold separately) is attached and [REF. LIGHT MODE] is set to [NORMAL], [REF. LIGHT ADJUST] is set to [100] (100 - 130 VAC: [85]), and [PRESET] is set to [STANDARD]. Using [REF. LIGHT ADJUST] will reduce brightness. If any other mode is selected as the [PRESET] mode, the light output value may drop slightly.
- *3 Compliance with ISO21118-2020
- *4 If you are unable to view material via the HDMI input, this does not necessarily mean the projector is not functioning properly. With the implementation of HDCP, there may be cases in which certain content is protected with HDCP and might not be displayed due to the decision/intention of the HDCP community (Digital Content Protection, LLC).
Video: HDR, Deep Color, 8/10/12-bit, Lip Sync.
HDMI: Supports HDCP 2.2/1.4
HDBaseT: Supports HDCP 2.2/1.4
DisplayPort: Supports HDCP 1.3
- *5 The projector's protection functions will activate depending on the temperature of the operating environment. (→ page 35)
- For additional information visit:
US: <https://business.sharpusa.com/>
Europe: <https://www.sharpnecdisplays.eu>
Global: <https://www.sharp-nec-displays.com/global/>
For information on our optional accessories, visit our website or see our brochure.

The specifications are subject to change without notice.

Option lens (sold separately)

XP-57UL	Motorized lens shift, Motorized zoom, Motorized focus (Throw ratio 0.31 - 0.33:1 F 2.05 - 2.11, f= 5.81 - 6.17 mm)
XP-58ZL	Motorized lens shift, Motorized zoom, Motorized focus (Throw ratio 0.55 - 0.75:1 F 2.04 - 2.35, f= 10.03 - 13.60 mm)
XP-59ZL	Motorized lens shift, Motorized zoom, Motorized focus (Throw ratio 0.74 - 1.08:1 F 2.02 - 2.33, f= 13.47 - 19.67 mm)
XP-60ZL	Motorized lens shift, Motorized zoom, Motorized focus (Throw ratio 1.05 - 1.41:1 F 1.90 - 2.08, f= 8.78 - 25.30 mm)
XP-61ZL	Motorized lens shift, Motorized zoom, Motorized focus (Throw ratio 1.40 - 2.11:1 F 1.80 - 2.11, f= 25.04 - 37.57 mm)
XP-62ZL	Motorized lens shift, Motorized zoom, Motorized focus (Throw ratio 2.10 - 4.00:1 F 1.90 - 2.44, f= 37.23 - 70.60 mm)

NOTE:

- The above throw ratio is for projecting on 100" screen.
- The release date of XP-57UL is undecided.

Please refer to our website for release schedule.

8-4. Cabinet Dimensions

Unit: mm (inch)

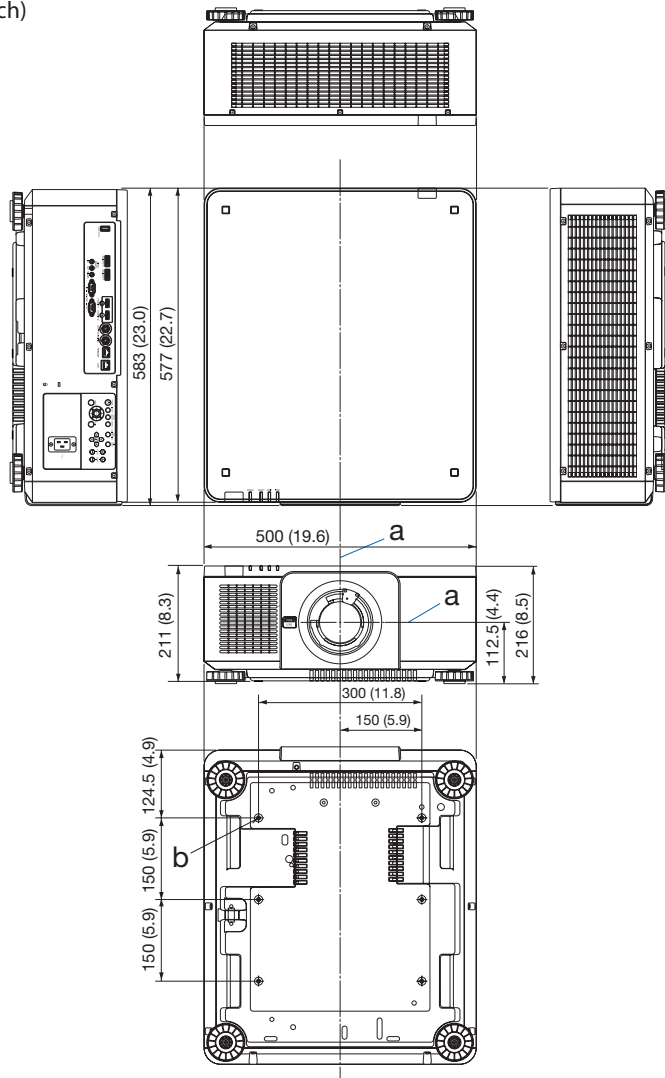

a: Lens center / b: 6 M4mm screw holes of 15 mm depth (for Ceiling Mount)*

* Consult your dealer for installing the projector on the ceiling.

To the dealer and the installer

Be sure to fasten the ceiling mount fittings securely, using all 6 screw holes.

8-5. Pin assignments and signal names of main connectors

HDMI 1 IN/HDMI 2 IN Connector (Type A)

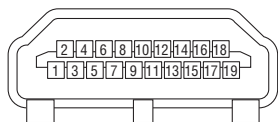

Pin No.	Signal
1	TMDS Data 2+
2	TMDS Data 2 Shield
3	TMDS Data 2-
4	TMDS Data 1+
5	TMDS Data 1 Shield
6	TMDS Data 1-
7	TMDS Data 0+
8	TMDS Data 0 Shield
9	TMDS Data 0-
10	TMDS Clock +
11	TMDS Clock Shield
12	TMDS Clock-
13	CEC
14	Disconnection
15	SCL
16	SDA
17	DDC/CEC grounding
18	+5 V power supply
19	Hot plug detection

HDBaseT Port (RJ-45)

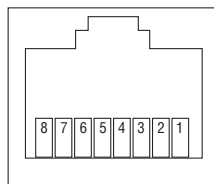

Pin No.	Signal
1	TxD+/HDBT0+
2	TxD-/HDBT0-
3	RxD+/HDBT1+
4	Disconnection/HDBT2+
5	Disconnection/HDBT2-
6	RxD-/HDBT1-
7	Disconnection/HDBT3+
8	Disconnection/HDBT3-

USB Port (Type A)

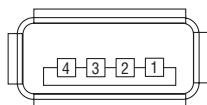

Pin No.	Signal
1	V _{BUS}
2	D-
3	D+
4	Grounding

RS-232C Port (D-Sub 9 Pin)

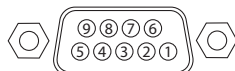

Pin No.	Signal
1	Unused
2	RxD reception data
3	TxD transmission data
4	Unused
5	Grounding
6	Unused
7	RTS transmission request
8	CTS transmission allowed
9	Unused

DisplayPort IN 1/2 Terminal

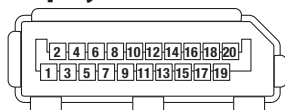

Pin No.	Signal	Pin No.	Signal
1	Main link lane 3-	11	Grounding 0
2	Grounding 3	12	Main link lane 0+
3	Main link lane 3+	13	Configuration 1
4	Main link lane 2-	14	Configuration 2
5	Grounding 2	15	Supplementary channel +
6	Main link lane 2+	16	Grounding 4
7	Main link lane 1-	17	Supplementary channel -
8	Grounding 1	18	Hot plug detection
9	Main link lane 1+	19	Return
10	Main link lane 0-	20	+3.3 V power supply

Screen Trigger (Stereo mini)

When the projector is powered ON the screen trigger output sends a low voltage trigger to the screen controller and the screen will go down. When the projector is powered OFF the screen trigger stops sending a low voltage trigger to the screen controller and the screen will go up.

NOTE:

- To use this feature, you must turn on the [TRIGGER] function. See "TRIGGER" on page 69 for more information.
-

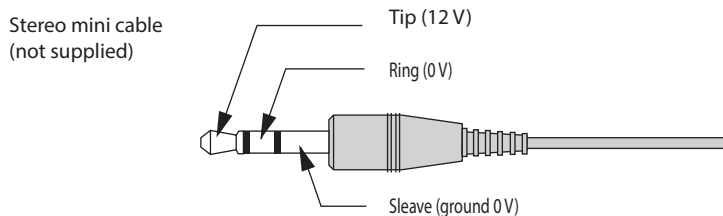

NOTE:

- Screen controllers are supplied and supported by screen manufacturers.
-

NOTE:

- Do not use these terminals for anything other than intended use. Connecting the wired remote control to the TRIGGER 1/2 terminals causes damage to the remote control.
-

8-6. Portrait projection (vertical orientation)

This projector can be installed vertically to display computer images in portrait orientation.

Direction of On-Screen display (menu, source display and messages) can be changed by the menu [SETUP(2)]

→ [MENU] → [MENU ANGLE].

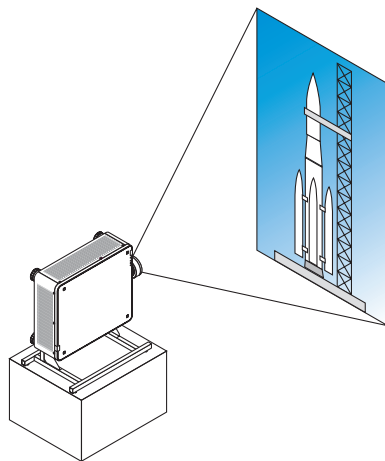

Precautions during installation

- Please do not install the projector in a vertical orientation on top of the floor or table on its own. If not, the projector may fall over, resulting in injury, damage or malfunction.
- A stand for supporting the projector needs to be made for this purpose to keep intake air flow securely and preventive measure of falling over. The stand must be designed such that the center of gravity of the projector is located well within the legs of the stand. If not, the projector may fall over and result in injury, damage and malfunction.
- If the projector is installed on which the intake vent facing down, optical part life may be shorten.

Design and manufacturing conditions for the stand

Please hire an installation service provider (for a fee) for the design and manufacture of a customized stand to be used for portrait projection. Please ensure that the design complies with the following conditions:

- There are 3 ventilation holes at the bottom of the projector. These holes should remain unobstructed.
- Use the 6 screw holes at the back of the projector to secure it to the stand.
Screw hole center dimension: 300×300 (pitch = 150) mm
Screw hole dimension on the projector: M4 with the maximum depth 15 mm
4 of the legs can be unscrewed for removal.
- Horizontal adjustment mechanism (for example, bolts and nuts in 4 places)
- Please design the stand so that it does not easily topple over.

Reference drawings

* The drawing showing the dimensional requirements is not an actual stand design drawing.

(Unit: mm)

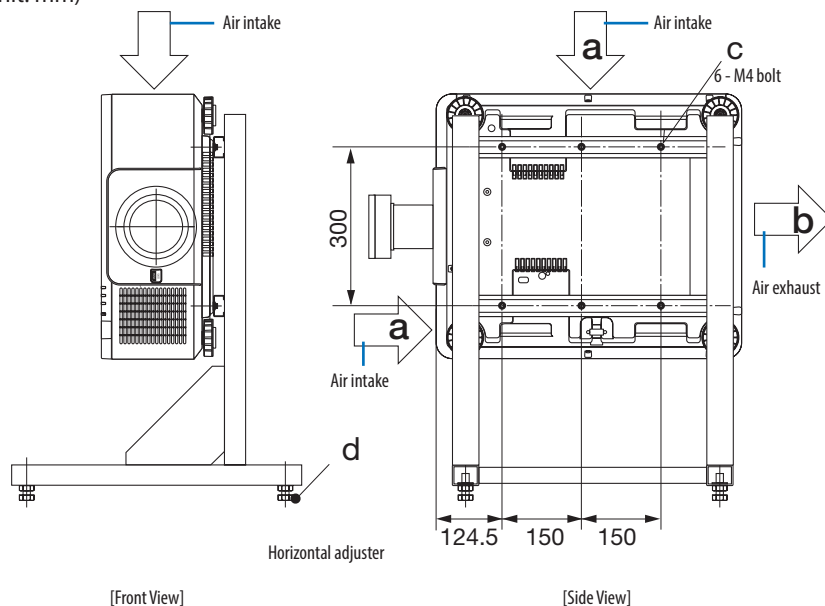

8-7. Stacking projectors

The projected image brightness can be doubled by gravity stacking up to two projectors without external support. This is called "Stacking Projection".

2 projectors can be stacked on top of each other for "Stacking" setup.

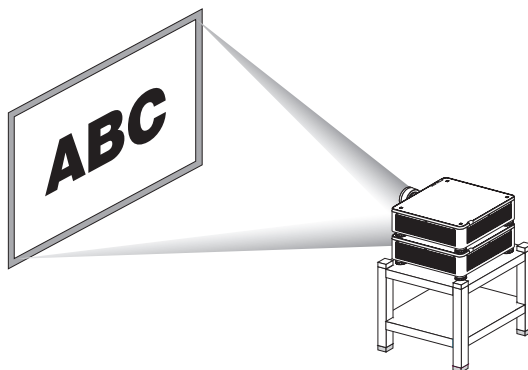

CAUTION:

- A minimum of two persons are required to carry the projector. Otherwise the projector may tumble or drop, causing personal injury.
- Grip the handles for moving the projector.

NOTE:

- Projectors with different model numbers cannot be gravity stacked. Optional lenses with the same model numbers must be used for stacking projection.
- For stacking projectors, attach the supplied four stacking holders to the top of the lower projector. (→ [next page](#))
- It does not support overlay accuracy by stacked projectors. Precise images as small texts and detailed graphics can not be clearly read or seen.
- Use a commercially available distribution amplifier to both the primary (upper) and the secondary (lower) projectors to distribute signal to two outputs of the two projectors.
- Notes for stacking
 - Ask your service person for setting up and adjusting projectors.
 - Set up the projectors in a place or structure in a way with sufficient strength to support the combined weight of the two projectors. The single projector with a lens weighs up to approximately 33 kg/ 73 lbs.
 - To prevent the projectors from falling, fasten them in a way to withstand earthquakes.
 - Double stacking will cause room temperature to increase. Ventilate the room well.
 - Do not attempt to stack projectors on the ceiling. Gravity stacking cannot be done on the ceiling.
 - Warm up the projectors for one hour before the desired projection is obtained.
 - Make sure that the position of the upper projector does not exceed its specifications. When setting up the two projectors, adjustable height range for the tilt foot on the upper projector is added to the total adjustable range.
 - Set up the projectors so that the projected image shows as little geometric distortions as possible. The lens is different in geometric distortion between wide(+) and tele(-) for zoom.
 - Adjust the horizontal lens shift to the lens center.

Attaching Stacking Holders

Attach four stacking holders to four locations on the top of the lower projector.

Preparation:

Tools required are Phillips screwdriver (plus-head) and four stacking holders packaged with the projector. Loosen the tilt foot (four locations) of the projector.

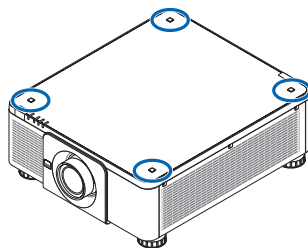

1. Remove rubber caps and screws at four locations.

- (1) Use your tweezers or nail to pinch and pull up the rubber cap.
- (2) Remove the screw from a square hole.

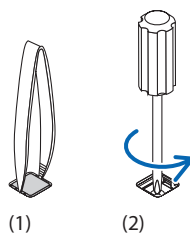

2. Attach the stacking holders at four locations.

- (1) Place a stacking holder in a square hole.
- (2) Use the screw removed at Step 1 to fix the stacking holder in the square hole.
- (3) Put the rubber cap removed at Step 1 back into the square hole.
 - Snap the tabs on both of the rubber cap into the slits on both sides in the square hole.

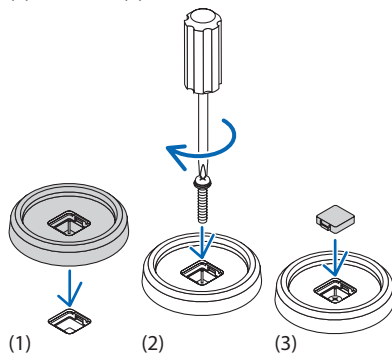

3. Put another projector on the first projector.

Put each tilt foot of the upper projector on the stacking holders (four locations).

- Each tilt foot has a rubber. Place each tilt foot rubber on stacking holders (four locations).

TIP:

- To remove the stacking holders, perform the above steps in reverse order.

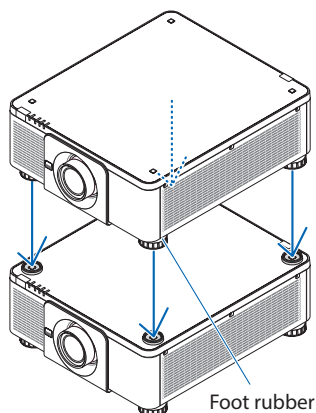

8-8. Troubleshooting

This section helps you resolve problems you may encounter while setting up or using the projector.

Feature of each indicator

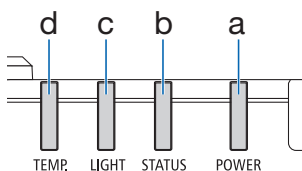





























a: POWER indicator







b: STATUS indicator

c: LIGHT indicator

d: TEMP. indicator

Indicator Message (Status message)

POWER	STATUS	LIGHT	TEMP.	Projector status
 Off	 Off	 Off	 Off	Power is off
 Orange (Blink ^{*1})	 Off	 Off	 Off	Now switching to the standby mode Main unit now cooling
 Red (Light)	 Off	 Off	 Off	In the state of Standby (Network is unavailable)
 Orange (Light)	 Off	 Off	 Off	In the state of Standby (Network is available)
 Green (Light)	 Off	 Green (Light)	 Off	Powered state
 Green (Light)	 Off	 Green (Blink ^{*1})	 Off	Powered state ([FAN MODE] is [HIGH])
Status varies	 Orange (Blink ^{*2})	Status varies	 Off	[LENS CALIBRATION] implement request.
 Green (Light)	 Green (Blink ^{*2})	Status varies	 Off	Performing the lens calibration















POWER	STATUS	LIGHT	TEMP.	Projector status
 Green (Light)	Status varies	 Green (Blink*3)	 Off	Shutter function is activating
 Green (Blink*1)	 Off	 Off	 Off	Preparing for powering [ON]

*1 Repetition to light on for 0.5 seconds / off for 0.5 seconds

*2 Repetition to light on for 0.5 seconds / off for 0.5 seconds / on for 0.5 seconds / off for 2 seconds

*3 Repetition to light on for 0.5 seconds / off for 5 seconds

Indicator Message (Error message)

POWER	STATUS	LIGHT	TEMP.	Projector status	Procedure
 Green (Light)	 Off	 Orange (Light)	 Off	Temperature problem	Ambient temperature is high. The projector's protection functions will activate depending on the temperature of the operating environment. Lower the room temperature.
 Green (Light)	 Off	 Off	 Red (Blink*1)	Temperature problem	Ambient temperature is out of the operation temperature. Check if any obstruction stays near the exhaust vent.
Status varies	 Red (Blink*4)	 Off	 Off	Lens mounting error	Lens is not mounted properly. Mount it.
Status varies	 Red (flashing other than as describe above) Or (lit)	Status varies	 Off	Error requiring service support	Contact your dealer or service personnel. Make sure to check and inform indicator status for asking to repair.
	Status varies	 Red (Blink*2,*4)			

*1 Repetition to light on for 0.5 seconds / off for 0.5 seconds

*2 Repetition to light on for 0.5 seconds / off for 0.5 seconds / on for 0.5 seconds / off for 2 seconds

*4 Repetition to light on for 0.5 seconds / off for 2 seconds

When the thermal protector is activated:

When inside temperature of the projector becomes too high or low, the TEMP. indicator start to red blink in a short cycle. After this happened, the thermal protector will activate and the projector may be turned off.

In this case, please take the below measures:

- Pull out the power plug from the wall inlet.
- Place the projector in cool place if it has been placed in high ambient temperature.
- Clean the exhaust vent if dust has accumulated on.
- Leave the projector for about one hour until inside temperature gets lower.

Common Problems & Solutions

Problem	Check These Items
Does not turn on or shut down	<ul style="list-style-type: none"> • Check that the power cord is plugged in and that the power button on the projector cabinet or the remote control is on. (→ pages 18, 20) • Check to see if the projector has temperature error, If projector inside temperature is too hot or cool, it disabled to turn on the projector as the protection. Wait for a moment and try turn on the projector again. • In case it's hard to think the trouble is not caused on the above mentioned conditions, unplug the power cord from the outlet. Then wait 5 minutes before plugging it in again. (→ page 31)
Will turn off	<ul style="list-style-type: none"> • Ensure that the [AUTO POWER OFF] is off. (→ page 72)
No picture	<ul style="list-style-type: none"> • Check if the appropriate input is selected. (→ page 23) If there is still no picture, press the INPUT button or one of the input buttons again. • Ensure your cables are connected properly. • Use menus to adjust the brightness and contrast. • Check that the SHUTTER CLOSE button is not pressed. • Reset the settings or adjustments to factory preset levels using the [RESET] in the Menu. (→ page 73) • If the HDMI input signal cannot be displayed, try the following. Reinstall your driver for the graphics card built in your computer, or use the updated driver. For reinstalling or updating your driver, refer to the user guide accompanied with your computer or graphics card, or contact the support center for your computer manufacturer. Install the updated driver or OS on your own responsibility. We are not liable for any trouble and failure caused by this installation. • The signal may not be supported depending on the HDBaseT transmission device. In addition, RS-232C interface may not be supported. • If the projector is kept in sleep mode or other similar state, the temperature of the internal components could rise even when the projector is being used within its normal operating temperate. If the power is ON when that occurs, the cooling fan will turn on and it will take a little bit of time before the image is projected. Please wait for a while.
Picture suddenly becomes dark	<ul style="list-style-type: none"> • A hot room may trigger the projector's protection functions, which can result in a temporary reduction in luminance (brightness). Reduce the temperature in the room.
Image isn't square to the screen	<ul style="list-style-type: none"> • Reposition the projector to improve its angle to the screen. (→ page 24) • Perform [GEOMETRIC CORRECTION] when the trapezoid is distorted. (→ page 61)
Picture is blurred	<ul style="list-style-type: none"> • Adjust the focus. (→ page 27) • Reposition the projector to improve its angle to the screen. (→ page 24) • Ensure that the distance between the projector and screen is within the adjustment range of the lens. (→ page 85) • Has the lens been shifted by an amount exceeding the guaranteed range? (→ page 89) • Condensation may form on the lens if the projector is cold, brought into a warm place and is then turned on. Should this happen, let the projector stand until there is no condensation on the lens.
Image is scrolling vertically, horizontally or both	<ul style="list-style-type: none"> • Check the computer's resolution and frequency. Make sure that the resolution you are trying to display is supported by the projector. (→ page 91)

Problem	Check These Items
Remote control does not work	<ul style="list-style-type: none"> • Aim the remote control's infrared transmitter towards the projector's remote control receiver. (→ page 15) • Install new batteries. (→ page 14) • Make sure there are no obstacles between you and the projector. • Stand within 7 m/276 inch of the projector. (→ page 15) • If a [CONTROL ID] has been set, check whether the ID number for the remote control matches the ID number for the projector. (→ page 68)
On-screen menu is not displayed	<ul style="list-style-type: none"> • Check whether On-screen mute is active. (→ page 33) On-screen mute can be turned off in the following ways: <ul style="list-style-type: none"> - Press the OSD OPEN button while holding down the CTL button on the remote control.
Indicator is lit or blinking	<ul style="list-style-type: none"> • See the Indicator Message. (→ page 105)

For more information contact your dealer.

8-9. PC Control Codes and Cable Connection

PC Control Codes

Command Format - A

Function	Code Data							
POWER ON	02H	00H	00H	00H	00H	02H		
POWER OFF	02H	01H	00H	00H	00H	03H		
INPUT SELECT HDMI1	02H	03H	00H	00H	02H	01H	A1H	A9H
INPUT SELECT HDMI2	02H	03H	00H	00H	02H	01H	A2H	AAH
INPUT SELECT DisplayPort1	02H	03H	00H	00H	02H	01H	A6H	AEH
INPUT SELECT DisplayPort2	02H	03H	00H	00H	02H	01H	A7H	AFH
INPUT SELECT SDI	02H	03H	00H	00H	02H	01H	C4H	CCH
INPUT SELECT HDBaseT	02H	03H	00H	00H	02H	01H	BFH	C7H

Command Format - B

Function	Code Data								
POWER ON	P	O	W	R	(SP)	(SP)	(SP)	1	(CR)
POWER OFF	P	O	W	R	(SP)	(SP)	(SP)	0	(CR)
INPUT SELECT HDMI1	I	R	G	B	(SP)	(SP)	3	1	(CR)
INPUT SELECT HDMI2	I	R	G	B	(SP)	(SP)	3	2	(CR)
INPUT SELECT DisplayPort1	I	R	G	B	(SP)	(SP)	3	3	(CR)
INPUT SELECT DisplayPort2	I	R	G	B	(SP)	(SP)	3	4	(CR)
INPUT SELECT SDI	I	R	G	B	(SP)	(SP)	3	5	(CR)
INPUT SELECT HDBaseT	I	N	E	T	(SP)	(SP)	5	1	(CR)
BLANK OFF	I	M	B	K	(SP)	(SP)	(SP)	0	(CR)
BLANK ON	I	M	B	K	(SP)	(SP)	(SP)	1	(CR)

NOTE:

- Command formats A and B are identified automatically.
- (SP) in Parameter area means "20H" in ASCII code.
(CR) in Parameter area means "0DH" in ASCII code.
- Contact your local dealer for a full list of the PC Control Codes if needed.

Cable Connection

Communication Protocol

Baud rate	9600 bps
Data length	8 bits
Parity	No parity
Stop bit	One bit
X on/off	None
Communications procedure	Full duplex

NOTE:

- Depending on the equipment, a lower baud rate may be recommended for long cable runs.

RS-232C Port (D-SUB 9P)

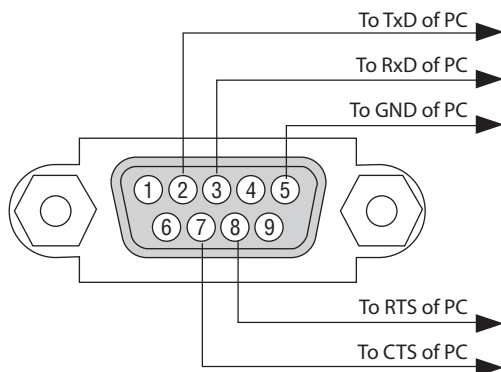

NOTE:

- Pins 1, 4, 6 and 9 are no used.
- Jumper "Request to Send" and "Clear to Send" together on both ends of the cable to simplify cable connection.

8-10. Troubleshooting Check List

Before contacting your dealer or service personnel, check the following list to be sure repairs are needed also by referring to the “Troubleshooting” section in your user’s manual. This checklist below will help us solve your problem more efficiently.

* Print this page and the next page for your check.

Frequency of occurrence:

always sometimes (How often? _____) other (_____)

Power

- No power (POWER indicator does not light blue). See also “Status Indicator (STATUS)”.
- Power cord’s plug is fully inserted into the wall outlet.
- No power even though you press and hold the POWER button.
- Shut down during operation.
 - Power cord’s plug is fully inserted into the wall outlet.
 - [AUTO POWER OFF] is turned off (only models with the [AUTO POWER OFF] function).
 - [OFF TIMER] is turned off (only models with the [OFF TIMER] function).

Video

- No image is displayed from your PC or video equipment to the projector.
 - Still no image even though you connect the projector to the PC first, then start the PC.
 - Enabling your notebook PC’s signal output to the projector.
 - A combination of function keys will enable/disable the external display. Usually, the combination of the “Fn” key along with one of the 12 function keys turns the external display on or off.
 - No image (blue or black background, no display).
 - Still no image even though you carry out [RESET] in the projector’s menu.
 - Signal cable’s plug is fully inserted into the input terminal
 - A message appears on the screen. (_____)
 - The source connected to the projector is active and available.
 - Still no image even though you adjust the brightness and/or the contrast.
 - Input source’s resolution and frequency are supported by the projector.
- Image is too dark.
 - Remains unchanged even though you adjust the brightness and/or the contrast.
- Image is distorted.
 - Image appears to be trapezoidal (unchanged even though you carry out the [KEYSTONE] adjustment).
- Parts of the image are lost.
 - Still unchanged even though you carry out [RESET] in the projector’s menu.
- Image is shifted in the vertical or horizontal direction.
 - Horizontal and vertical positions are correctly adjusted on a computer signal.
 - Input source’s resolution and frequency are supported by the projector.
 - Some pixels are lost.
- Image is flickering.
 - Still unchanged even though you carry out [RESET] in the projector’s menu.
 - Image shows flickering or color drift on a computer signal.
- Image appears blurry or out of focus.
 - Still unchanged even though you checked the signal’s resolution on PC and changed it to projector’s native resolution.
 - Still unchanged even though you adjusted the focus.

Other

- Remote control does not work.
 - No obstacles between the sensor of the projector and the remote control.
 - Projector is placed near a fluorescent light that can disturb the infrared remote controls.
 - Batteries are new and are not reversed in installation.
- Buttons on the projector cabinet do not work (only models with the [CONTROL PANEL LOCK] function)
 - [CONTROL PANEL LOCK] is not turned on or is disabled in the menu.
 - Still unchanged even though you press and hold the EXIT button over 10 seconds.

In the space below please describe your problem in detail.

Information on application and environment where your projector is used

Projector

Model number:

Serial No.:

Date of purchase:

Light module operating time (hours):

REF. LIGHT MODE: ECO NORMAL
 FULL

Information on input signal:

Horizontal synch frequency [] kHz

Vertical synch frequency [] Hz

Synch polarity H (+) (-)
V (+) (-)

Indicator Message:

POWER Blinks in Blue Green Orange Red
[] cycles

Lights in Blue Green Orange Red

STATUS Blinks in Blue Green Orange Red
[] cycles

Lights in Blue Green Orange Red

LIGHT Blinks in Blue Green Orange Red
[] cycles

Lights in Blue Green Orange Red

TEMP. Blinks in Blue Green Orange Red
[] cycles

Lights in Blue Green Orange Red

Remote control model number:

Signal cable

SHARP standard or other manufacturer's cable?

Model number: Length: inch/m

Distribution amplifier

Model number:

Switcher

Model number:

Adapter

Model number:

Installation environment

Screen size: inch

Screen type: White matte Beads Polarization
 Wide angle High contrast

Throw distance: feet/inch/m

Orientation: Ceiling mount Desktop

Power outlet connection:

- Connected directly to wall outlet
- Connected to power cord extender or other (the number of connected equipment _____)
- Connected to a power cord reel or other (the number of connected equipment _____)

Computer

Manufacturer:

Model number:

Notebook PC / Desktop

Native resolution:

Refresh rate:

Video adapter:

Other:

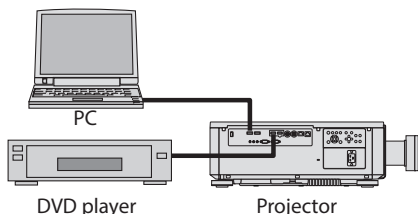

Video equipment

VCR, DVD player, Video camera, Video game or other

Manufacturer:

Model number:

8-11. Setting the login password for the HTTP server screen

When connecting to the HTTP server for the first time after purchasing the projector, be sure to set a password.

Preparation:

- Connect the projector to the computer with a LAN cable sold commercially. (→ page 82)
- Select [SETUP(1)] → [NETWORK SETTINGS] → [WIRED LAN] in the on-screen menu to configure the network settings. (→ page 71)

1. Start up the web browser on your computer and enter the address or URL in the input field.

Specify the address or URL as “http://<IP Address of Projector>/index.html”.

The HTTP server login screen will be displayed.

XP-X141Q Login

IP ADDRESS: 192.168.0.100
MAC ADDRESS: 04:92:34:D6:00:FF

Username

admin

Password

Enter Password

Show Password

Login

2. Enter the initial password in the Password field and click the Login button.

- The initial password is the 12 digits of the MAC address without the colons.

For example, if the MAC address is 00:00:5E:00:53:00, then the initial password would be 00005E005300.

A screen will appear asking you to change the password.

Change Password

IP ADDRESS: 192.168.0.100
MAC ADDRESS: 04:92:34:D6:00:FF

Username

admin

New Password

password

Confirm Password

password

Show Password

Login

3. Enter your new password in the New Password field, enter the same password in the Confirm Password field and then click the Login button.

- The password can be a combination of up to 18 letters, numbers, and special characters.
0 to 9, A to Z, a to z, @ . _ -

Once the password has been set, the HTTP server screen will appear.

NOTE:

- Make a note of your password and store it in a safe place.
 - When you enter the password, pay enough attention to people around for the password abuse prevention.
If you have anxiety the password is cheated, change the password immediately.
-

8-12. Registering a background logo

An image can be sent to the projector and registered as the background logo.

Prepare an image for the logo

Logo image requirements

- File name : UserLogo.bmp
- File format : BMP (RGB565)
- Image size : Up to 1920 x 1200
- Color depth : Up to 16 bit

Download the batch file

- ① Visit our website.
https://www.sharp-nec-displays.com/dl/en/pj_manual/x141q.html
- ② Store UserLogo.bat on the computer.

Set up the network

- ① Select [SETUP(1)] → [NETWORK SETTINGS] → [WIRED LAN] in the on-screen menu to set up the network settings of the projector. (→ Installation Manual: page 71)
IP ADDRESS : 192.168.0.XXX
- ② Set [SETUP(2)] → [POWER OPTIONS] → [STANDBY MODE] to [LAN] in the on-screen menu.
- ③ Turn off the projector and go into the standby mode.
- ④ Set up your computer's network.
IP ADDRESS: 192.168.0.YYY
SUBNET MASK: 255.255.255.0 (same as projector)

Enable TFTP

- ① Press the "Windows" and "R" keys on your computer at the same time.
The "Run" window will open.
- ② Input "appwiz.cpl" and click "OK".
- ③ Click "Enable Windows Function", then check to "TFTP Client" and click "OK".
- ④ Reboot your computer.

Send the image to the projector

- ① Connect the projector and computer using LAN cable and RS-232C cable.
- ② Power on the projector.
- ③ Send RS-232C commands from the computer to the projector.
 1. Send "op demsg = 1", then receive "OP DEMSG = 1".
 2. Send "op active.warp = 6", then receive "OP ACTIVE.WARP = 6".
 3. Send "op dbf.send = 1".
 4. Run "UserLogo.bat", then receive "OP DBF.SEND = 1".
 5. Send "op cust.wp.write = 10", then receive "File Write Process Completely".
 6. Send "op dbf.send = 0", then receive "OP DBF.SEND = 0".
 7. Send "op active.warp = 0", then receive "OP ACTIVE.WARP = 0".
 8. Send "op demsg = 0", then receive "OP DEMSG = 0".

ASCII	HEX	Decimal	Binary	Communication
2024/11/19 15:54:39.092	[TX]	- op demsg = 1<CR>		
2024/11/19 15:54:39.136	[RX]	- OP DEMSG = 1<CR><LF>		
2024/11/19 15:54:42.791	[TX]	- op active.warp = 6<CR>		
2024/11/19 15:54:42.846	[RX]	- OP ACTIVE.WARP = 6<CR><LF>		
2024/11/19 15:54:45.799	[TX]	- op dbf.send = 1<CR>		
2024/11/19 15:55:31.402	[RX]	- UserLogo.bmpUserLogo.bmpuse the latest file<CR><LF> 0.open file = 399480<CR><LF> Write File to VDO, Ack Block Num = 0<CR><LF> VDO BD Open File DbD_EB.bin Done.<CR><LF> Transfer to VDO: (400571)<CR><LF> TFTP Transfer Done: (406448)<CR><LF> OP DBF_SEND = 1<CR><LF>		
2024/11/19 15:56:38.322	[TX]	- op cust.wp.write = 10<CR>		
2024/11/19 15:56:38.372	[RX]	- OP CUST.WP.WRITE = 10<CR><LF>		
[VDO] ### Chane state from 5 to 6<CR><LF>		[VDO] Heartbeat timeout!<CR><LF>		
[VDO] ### Chane state from 6 to 7<CR><LF>				
[VDO] ### Chane state from 7 to 8<CR><LF>				
[VDO] ### Chane state from 8 to 3<CR><LF>				
[VDO] ### Chane state from 3 to 4<CR><LF>				
[VDO] ### Chane state from 4 to 5<CR><LF>				
[SYS] Tx Packet ID(dfh) CL5-Cmd(60h-30h) Over TTL<CR><LF>				
File Write Process Completely.<CR><LF>				
2024/11/19 16:09:24.031	[TX]	- op dbf.send = 0<CR>		
2024/11/19 16:09:24.080	[RX]	- OP DBF_SEND = 0<CR><LF>		
2024/11/19 16:09:26.235	[TX]	- op active.warp = 0<CR>		
2024/11/19 16:09:26.290	[RX]	- OP ACTIVE.WARP = 0<CR><LF>		
2024/11/19 16:09:28.058	[TX]	- op demsg = 0<CR>		
2024/11/19 16:09:28.100	[RX]	- OP DEMSG = 0<CR><LF>		

④ Power off the projector.

The logo image is now registered on the projector.

After turning on the projector, when [SETUP(2)] → [BACKGROUND] on the on-screen menu is set to [LOGO], the image will be displayed on the background whenever there is no signal.

SHARP
SHARP CORPORATION